



2024





30 JAHRE ERFAHRUNG MIT FARBSPRITZTECHNIK

Diese langjährige Erfahrung macht Gemini GmbH zu einem der führenden Unternehmen im Bereich der Oberflächentechnik.

Gemini ist Produzent und Großhändler von Düsensystemen, Lackierpistolen, Farbspritzpumpen und -schläuchen sowie passendem Zubehör.

Unser Sortiment umfasst hochwertige Produkte namhafter Hersteller wie GRACO, ASM, WAGNER, WIWA, KREMLIN, ANESTIWATA, AIRGUNSA, PRONA und der Eigenmarke MASPRA.

30 YEARS OF EXPERIENCE WITH SURFACE TECHNOLOGY

This experience makes Gemini GmbH one of the leading companies in the paint spraying sector.

Gemini is a producer and wholesaler of spray tip systems, spray guns, pumps, hoses and matching accessories.

Our range includes high-quality products from well-known brands such as GRACO, ASM, WAGNER, WIWA, KREMLIN, ANEST IWATA, AIRGUNSA, PRONA and our own label MASPRA.



JEDE MARKE - ALLE ARTIKEL

Neben den im Katalog gezeigten Artikeln, erhalten Sie von uns alle Produkte und Ersatzteile der jeweiligen Marken und deren Divisionen.

- Hohe Warenverfügbarkeit
- Schneller Versand
- Zuverlässige Beratung
- Bestmögliche Konditionen

Kontaktieren Sie uns um Ihr persönliches Angebot zu erhalten und erfragen Sie Ihren Rabatt.

EACH BRAND - ALL PRODUCTS

In addition to the items shown in this catalogue, you'll get all products and spare parts of the respective brands and their divisions.

- High product availability
- Fast shipping
- Customer support
- Best possible prices

Contact us to receive your personalized offer and inquire about your discount.



MASPRA PRODUKTE VON GEMINI

Mit der eigenen **MASPRA** Produktreihe liefert Gemini eine zuverlässige und hochwertige Alternative, als preiswerte Ergänzung zu jedem Standardsortiment.

Option für Großkunden: 100% private label! Logo, Farbe und Gravur können bei MASPRA Produkten individuell abgestimmt werden, ebenso der Lieferumfang sowie das gesamte Marketingpaket.



MASPRA PRODUCTS BY GEMINI

With the own **MASPRA** product line, Gemini offers a reliable and high quality alternative, as an economic addition to every product range.

Quantity buy option: 100% private label! Logo, color and engraving of MASPRA products, can be individually customized, as well as the scope of delivery and the whole marketing package.



 **OPTION**
PRIVATE LABEL



MASPRA PARTNERSCHAFT

Unsere Produkte werden ausschließlich über den Vertrieb beworben, wobei wir ein umfassendes und leistungsfähiges Vertriebsnetzwerk etablieren.

Mit dem Ziel, unseren Service für Endkunden zu verbessern, sind wir auf der Suche nach weiteren Vertriebspartnern für spezifische Märkte in ausgewählten Regionen.

Werden Sie Teil des MASPRA Händlernetzes.



MASPRA PARTNERSHIP

We exclusively promote our products through distribution and have established an extensive and efficient sales network.

In an effort to optimize our service for end customers, we are seeking additional distribution partners for specific markets in selected regions.

Be part of the MASPRA dealer network.





VERKAUFSDISPLAYS POINT OF SALE DISPLAYS

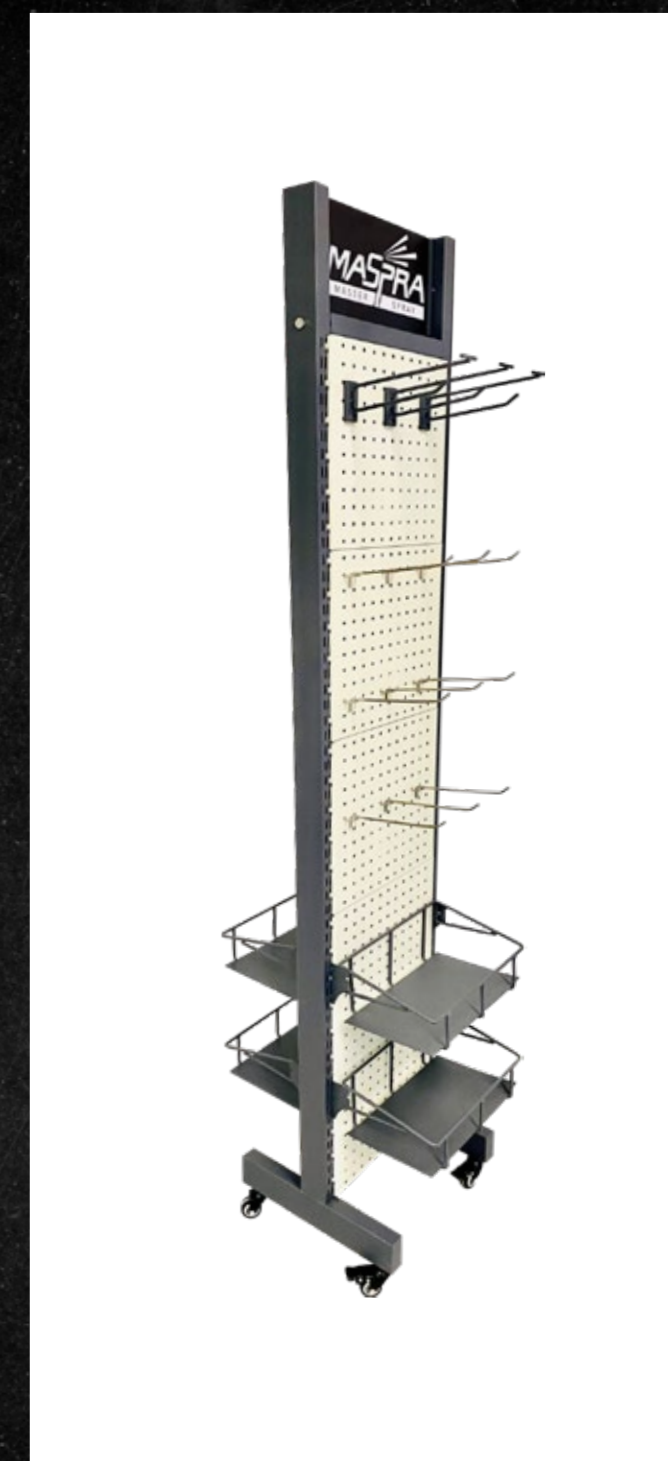

Elektrische Membranpumpen

Electric diaphragm pumps

12 - 17



Airless Spritzpistolen & Zubehör

Airless spray guns & accessories

48 - 59



Elektrische Kolbenpumpen

Electric piston pumps

18 - 31



Rohrinnenbeschichtung

Inner tube guns

60 - 61



Pneumatische Kolbenpumpen

Pneumatic piston pumps

32 - 33



AirCombi Spritzpistolen

AirCombi spray guns

62 - 65



HVLP

Turbine sprayer

34 - 35



Airless & AirCombi Düsensysteme

Airless & AirCombi tip systems

66 - 87



Pumpen Zubehör & Ansaugsysteme

Pump accessories & suction systems

36 - 43



Filtersysteme

Filter systems

88 - 99



Elektrische Mixer & Flächenspachtel

Electric mixer & smoothing blades

44 - 45



Farbspritzschläuche & Heizschläuche

Paint spray hoses & heated hoses

100 - 107



Bautenschutz

Building protection

46 - 47



Reinigen & All-In Kits

Cleaning & All-In kits

108 - 119



PRONA
Drucktanks / Pressure pots
122 - 125



ASM
142 - 145

PRONA
Doppelmembranpumpen / Double diaphragm pumps
126 - 127



GRACO CED
146 - 149

PRONA
Pneumatische Rührwerke / Pneumatic agitators
128 - 131



GRACO Heavy Duty
150 - 151

PRONA
Luftpistolen / Air guns
132 - 135



GRACO Finishing
152 - 155

PRONA
Automatik Pistolen / Automatic guns
136 - 137



WAGNER
156 - 157

AIRGUNSA & ANEST IWATA
Luftpistolen / Air guns
138 - 139



WIWA & KREMLIN
158 - 159

Niederdruck Zubehör
Low pressure accessories
140 - 141



FORMECO
160 - 161

ELECTRIC DIAPHRAGM PUMP SERIES

MA-A4000

0.021" | 4 ltr./min. | 22 kg



Art.-Nr. / Part-No.
MA-A4000

MASPRA Airless Pumpe A4000 auf Tragegestell

- 6 Liter Oberbehälter mit Filter
- Rücklauf

MASPRA Airless pump A4000 on frame

- 6 liter hopper with filter
- Return pipe

2.100,- € Listenpreis
List price



Art.-Nr. / Part-No.
MA-A4000-AL

MASPRA A4000 SprayPack:

- Oberbehälter: 6 Liter
- Schlauch: 3/16" - 7,5 m - 1/4" NPS
- Pistole: 500 bar - 3 mm Kugel
- Filter: gelb
- Düse & Halter: Maspra - 415

- Hopper: 30 liters
- Hose: 3/16" - 7,5 m - 1/4" NPS
- Gun: 500 bar - 3 mm ball
- Filter: yellow
- Tip & base: MASPRA - 415

2.400,- € Listenpreis
List price



ELECTRIC DIAPHRAGM PUMP SERIES

MA-A5000

0.025" | 5 ltr./min. | 29 kg



Art.-Nr. / Part-No.
MA-A5000

MASPRA Airless Pumpe
A5000 auf Fahrwagen
inklusive Manometer-
Kombination

MASPRA Airless pump
A5000 on trolley
including gauge set

2.600,- € Listenpreis
List price



Art.-Nr. / Part-No.
MA-A5000-AL1

MASPRA A5000 SprayPack:

- Oberbehälter: 30 Liter
- Schlauch: 1/4" - 15 m - 1/4" NPS
- Pistole: 500 bar - 3 mm Kugel
- Filter: weiß
- Düse & Halter: Maspra - 421

- Hopper: 30 liters
- Hose: 1/4" - 15 m - 1/4" NPS
- Gun: 500 bar - 3 mm ball
- Filter: white
- Tip & base: MASPRA - 421

3.250,- € Listenpreis
List price



Art.-Nr. / Part-No.
MA-A5000-AL2

MASPRA A5000 SprayPack:

- Flexibles Ansaugsystem: NW19
- Schlauch: 1/4" - 15 m - 1/4" NPS
- Pistole: 500 bar - 3 mm Kugel
- Filter: weiß
- Düse & Halter: Maspra - 421

- Flexible suction system: NW19
- Hose: 1/4" - 15 m - 1/4" NPS
- Gun: 500 bar - 3 mm ball
- Filter: white
- Tip & base: MASPRA - 421

3.250,- € Listenpreis
List price



ELECTRIC DIAPHRAGM PUMP SERIES

MA-A10000

0.041" | 9 ltr./min. | 46 kg



Art.-Nr. / Part-No.
MA-A10000

MASPRA Airless Pumpe
A10000 auf Fahrwagen
inklusive Manometer-
Kombination

MASPRA Airless pump
A10000 on trolley
including gauge set

2.650,- € Listenpreis
List price



Art.-Nr. / Part-No.
MA-A10000-AL1

MASPRA A10000 SprayPack:

- Oberbehälter: 30 Liter
- Schlauch: 1/4" - 15 m - 1/4" NPS
- Pistole: 500 bar - 5 mm Kugel
- Filter: weiß
- Düse & Halter: Maspra - 427

- Hopper: 30 liters
- Hose: 1/4" - 15 m - 1/4" NPS
- Gun: 500 bar - 5 mm ball
- Filter: white
- Tip & base: MASPRA - 427

3.800,- € Listenpreis
List price



Art.-Nr. / Part-No.
MA-A10000-AL2

MASPRA A10000 SprayPack:

- Flexibles Ansaugsystem: NW25
- Schlauch: 1/4" - 15 m - 1/4" NPS
- Pistole: 500 bar - 5 mm Kugel
- Filter: weiß
- Düse & Halter: Maspra - 427

- Flexible suction system: NW25
- Hose: 1/4" - 15 m - 1/4" NPS
- Gun: 500 bar - 5 mm ball
- Filter: white
- Tip & base: MASPRA - 427

3.800,- € Listenpreis
List price



ELECTRIC PISTON PUMP SERIES

MA-EP19G

0.019" | 1.5 ltr./min. | 8 kg



Art.-Nr. / Part-No.
MA-EP-19

MASPRA Airless Pumpe
EP19 auf Tragegestell
inklusive flexiblem
Ansaugsystem

MASPRA Airless pump
EP19 on frame
including flexible suction
system

340,- € Listenpreis
List price



Art.-Nr. / Part-No.
MA-EP-19-SET

MASPRA EP19 SprayPack:

- Flexibles Ansaugsystem
- Schlauch: 3/16" - 7.5 m - 1/4" NPS
- Pistole: 250 bar - 3 mm Kugel
- Filter: weiß
- Düse & Halter: MASPRA - 517

- Flexible suction system
- Hose: 3/16" - 7.5 m - 1/4" NPS
- Gun: 250 bar - 3 mm ball
- Filter: white
- Tip & base: MASPRA - 517

520,- € Listenpreis
List price



Art.-Nr. / Part-No.
MA-EP-19-HOP
 MASPRA Airless Pumpe
 EP19 auf Tragegestell
 inklusive 5 Ltr. Oberbehälter
 MASPRA Airless pump
 EP19 on frame
 including 5 ltr. hopper
360,- € Listenpreis
 List price



Art.-Nr. / Part-No.
MA-EP-19-CART
 MASPRA Airless Pumpe
 EP19 auf Fahrwagen
 inklusive flexiblem
 Ansaugsystem
 MASPRA Airless pump
 EP19 on trolley
 including flexible suction
 system
400,- € Listenpreis
 List price



Art.-Nr. / Part-No.
MA-EP-19-HOP-SET
 MASPRA EP19 SprayPack:
 • 5 Ltr. Oberbehälter
 • Schlauch: 3/16" - 7.5 m - 1/4" NPS
 • Pistole: 250 bar - 3 mm Kugel
 • Filter: weiß
 • Düse & Halter: MASPRA - 517
 • 5 ltr. Oberbehälter
 • Hose: 3/16" - 7.5 m - 1/4" NPS
 • Gun: 250 bar - 3 mm ball
 • Filter: white
 • Tip & base: MASPRA - 517
540,- € Listenpreis
 List price



Art.-Nr. / Part-No.
MA-EP-19-CART-SET
 MASPRA EP19 SprayPack:
 • Flexibles Ansaugsystem
 • Schlauch: 3/16" - 7.5 m - 1/4" NPS
 • Pistole: 250 bar - 3 mm Kugel
 • Filter: weiß
 • Düse & Halter: MASPRA - 517
 • Flexible suction system
 • Hose: 3/16" - 7.5 m - 1/4" NPS
 • Gun: 250 bar - 3 mm ball
 • Filter: white
 • Tip & base: MASPRA - 517
580,- € Listenpreis
 List price



ELECTRIC PISTON PUMP SERIES

MA-EP21G

⚡ 0.021" | 2.0 ltr./min. | 15 kg



Art.-Nr. / Part-No.
MA-EP-21-G

MASPRA Airless Pumpe EP21 auf Tragegestell inklusive flexiblem Ansaugsystem

MASPRA Airless pump EP21 on frame including flexible suction system

1.300,- € Listenpreis
List price

Art.-Nr. / Part-No.
MA-EP-21-G-SET

MASPRA EP21 SprayPack:

- Flexibles Ansaugsystem
- Schlauch: 1/4" - 15 m - 1/4" NPS
- Pistole: 250 bar - 3 mm Kugel
- Düse & Halter: MASPRA - 311 & 517

- Flexible suction system
- Hose: 1/4" - 15 m - 1/4" NPS
- Gun: 250 bar - 3 mm ball
- Tip & base: MASPRA - 311 & 517

1.500,- € Listenpreis
List price



ELECTRIC PISTON PUMP SERIES

MA-EP29G

0.029" | 3.2 ltr./min. | 32 kg



Art.-Nr. / Part-No.
MA-EP-29-G

MASPRA Airless Pumpe
EP29 auf Fahrwagen
inklusive Ansaugsystem

MASPRA Airless pump
EP29 on trolley
including suction system

2.600,- € Listenpreis
List price

Art.-Nr. / Part-No.
MA-EP-29-G-SET

MASPRA EP29 SprayPack:

- Schlauch: 1/4" - 15 m - 1/4" NPS
- Pistole: 500 bar - 3 mm Kugel
- Düse & Halter: MASPRA - 517

- Hose: 1/4" - 15 m - 1/4" NPS
- Gun: 500 bar - 3 mm ball
- Tip & base: MASPRA - 517

3.000,- € Listenpreis
List price



ELECTRIC PISTON PUMP SERIES

MA-EP37G

0.037" | 5.0 ltr./min. | 57 kg

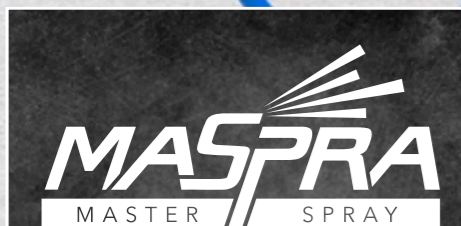

Art.-Nr. / Part-No.
MA-EP-37-G

MASPRA Airless Pumpe
EP37 auf Fahrwagen
inklusive Ansaugsystem

MASPRA Airless pump
EP37 on trolley
including suction system

4.600,- € Listenpreis
List price



Art.-Nr. / Part-No.
MA-EP-37-G-SET

MASPRA EP37 SprayPack:

- Schlauch: 3/8" - 15 m - 3/8" NPS
- Schlauchpeitsche: 1/4" - 1.5 m
- Pistole: 500 bar - 5 mm Kugel
- Düse & Halter: MASPRA - 517 & 535

- Hose: 3/8" - 15 m - 3/8" NPS
- Hose whip: 1/4" - 1.5 m
- Gun: 500 bar - 5 mm ball
- Tip & base: MASPRA - 517 & 535

5.000,- € Listenpreis
List price



ELECTRIC PISTON PUMP SERIES

MA-EP45G

0.045" | 8.0 ltr./min. | 52 kg



Art.-Nr. / Part-No.
MA-EP-45-G

MASPRA Airless Pumpe
EP45 auf Fahrwagen
inklusive Ansaugsystem

MASPRA Airless pump
EP45 on trolley
including suction system

5.800,- € Listenpreis
List price

Art.-Nr. / Part-No.
MA-EP-45-G-SET

MASPRA EP45 SprayPack:

- 2x Schlauch: 1/2" - 15 m - 1/2" NPS
- Schlauchpeitsche: 3/8" - 3.5 m
- Pistole: 250 bar - 5 mm Kugel
- Düse & Halter: MASPRA - 531 & 541
- Düsen- und Bürstenreinigung

- 2x Hoses: 1/2" - 15 m - 1/2" NPS
- Hose whip: 3/8" - 3.5 m
- Gun: 250 bar - 5 mm ball
- Tip & base: MASPRA - 531 & 541
- Tip and brush cleaning

6.200,- € Listenpreis
List price



GRAVITY FEED HOPPER



Art.-Nr. / Part-No.
MA-EP-HOP-60

- MASPRA Großmengen-
behälter**
- 60 Liter
 - Für Farbe und Spachtel
 - Inklusive Sackpresse und Deckel
 - Optional mit Rüttler

- MASPRA gravity feed
hopper**
- 60 liter
 - For paints and plasters
 - Including bag press and cover
 - Optional with shaker

1.300,- € Listenpreis
List price



Rüttler / Shaker



OPTIONAL

Aufpreis / surcharge
100,- €

Art.-Nr. / Part-No.
UNI-REEL-3/8-1.5

- MASPRA Universal
Schlauchaufroller**
- 3/8" NPS
 - Inkl. 1.5 m Verbindungsschlauch

- MASPRA Universal
hose reel**
- 3/8" NPS
 - Including 1.5 m hose connection

800,- € Listenpreis
List price

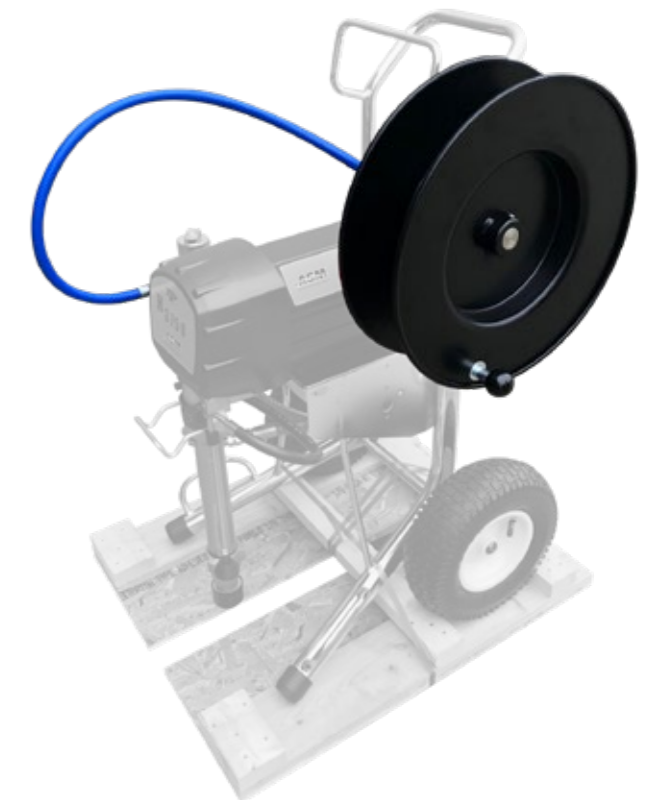

PNEUMATIC PISTON PUMP SERIES

MA-QUEEN-68
68:1 | 180 ccm | 2.9 ltr./min.



Art.-Nr. / Part-No.
MA-Q-68

MASPRA Airless Pumpe
QUEEN-68 auf Fahrwagen
inklusive Ansaugschlauch

MASPRA Airless pump
QUEEN-68 on trolley
including suction hose

4.400,- € Listenpreis
List price



Art.-Nr. / Part-No.
MA-Q-68-SET

MASPRA QUEEN-68 SprayPack

- Inkl. Ansaugschlauch
- Schlauch: 3/8" - 15 m - 500 bar
- Schlauchpeitsche: 1/4" - 1.8 m
- Pistole: 500 bar - 4 mm Kugel
- Düse & Halter: MASPRA - 519-HD

- Incl. suction hose
- Hose: 3/8" - 15 m - 500 bar
- Hose whip: 1/4" - 1.8 m
- Gun: 500 bar - 4 mm ball
- Tip & base: MASPRA - 519-HD

5.000,- € Listenpreis
List price



HVLP TURBINE SPRAYER

MA-HVLP-2800

1.400 W | 2.800 ltr./min. | Max. 0.41 bar

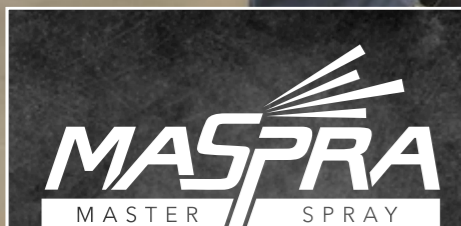

MA-HVLP-2800

MASPRA HVLP Sprayer HVLP-2800

- Inklusive Schlauch und Pistole
- Stufenlose Drehzahlregelung

MASPRA HVLP sprayer HVLP-2800

- including hose and gun
- Infinitely variable speed control for airflow

980,- € Listenpreis
List price

Art.-Nr. / Part-No. MA-HVLP-SET-xx

Düse & Nadel mit Luftkappe Nozzle & needle with AirCap

- 1.0 mmMA-HVLP-SET-10
- 1.2 mmMA-HVLP-SET-12
- 1.3 mmMA-HVLP-SET-13
- 1.8 mmMA-HVLP-SET-18
- 2.0 mmMA-HVLP-SET-20
- 2.5 mmMA-HVLP-SET-25

98,- € Listenpreis
List price



HIGH PRESSURE PUMP ACCESSORIES

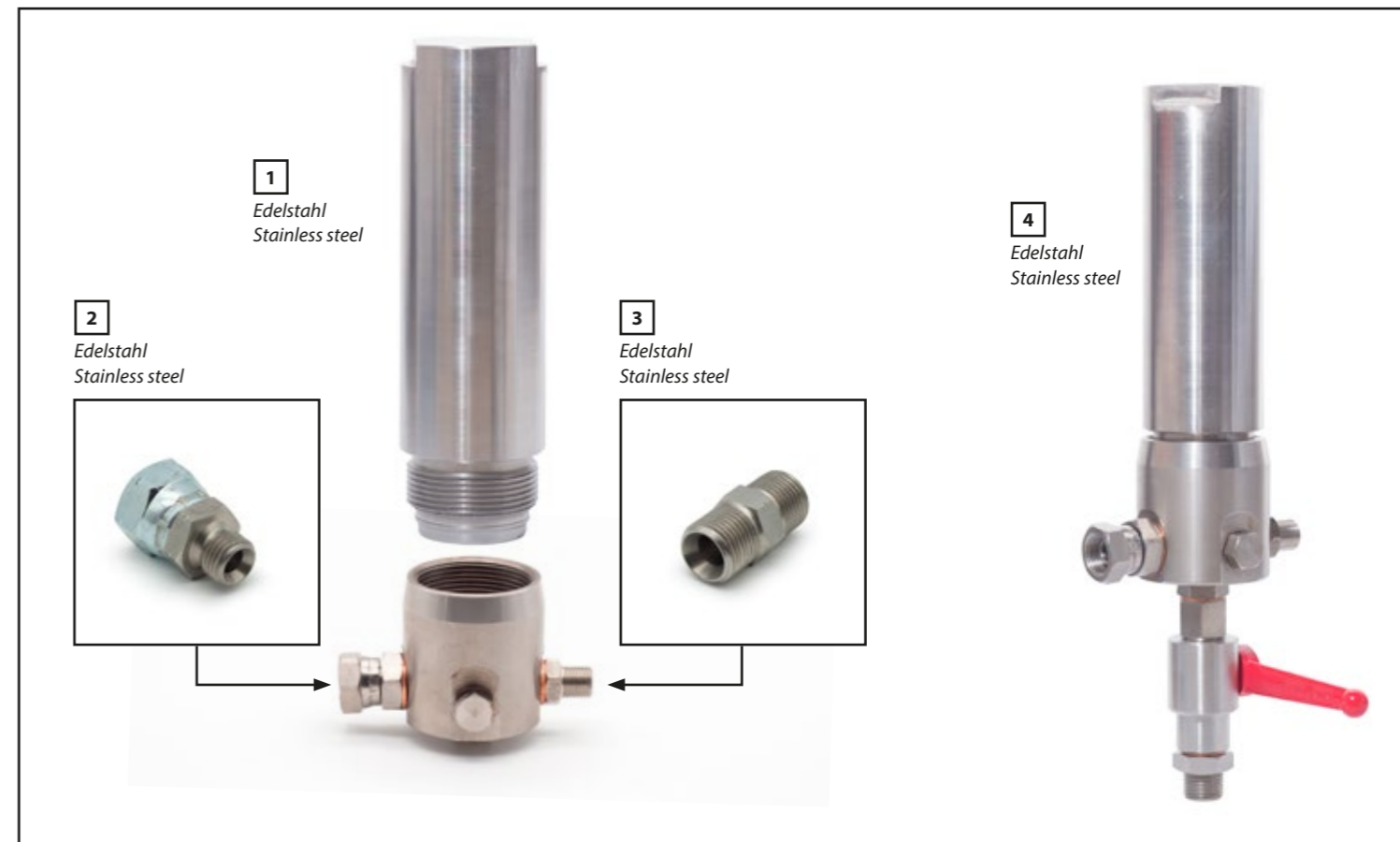

Pos.	Art.-Nr. Part-No.	Artikelbeschreibung Description	Listenpreis List price €/Stück €/piece	Netto-Stückpreis bei Net unit price for
------	----------------------	------------------------------------	---	--

HD-Filtergehäuse / HP-filter housing - 500 bar

1	HP-FI-LO-N	3/8" NPS (F) - 1/4" NPS (M) - Edelstahl / Stainless steel	198,-	
---	------------	---	-------	--

HD-Adapter / HP-adapter - 500 bar

			€/Stück €/piece	
2	M1/4Nx3/8N-SS	1/4" NPS (M) x 3/8" NPS (F) - Edelstahl / Stainless steel	16,-	
	M1/4Nx16-SS	1/4" NPS (M) x M16x1.5 (F) - Edelstahl / Stainless steel		
weitere Adapter auf Seite 58 / further adapters on page 58				

HD-Nippel / HP-nipple - 500 bar

			€/Stück €/piece	
3	M1/4NxM1/4N-SS	1/4" NPS (M) x 1/4" NPS (M) - Edelstahl / Stainless steel	16,-	
	M1/4NxM3/8N-SS	1/4" NPS (M) x 3/8" NPS (M) - Edelstahl / Stainless steel		
	M16xM1/4N-SS	M16x1.5 (M) x 1/4" NPS (M) - Edelstahl / Stainless steel		
weitere Nippel auf Seite 105 / further nipples on page 105				

HD-Filtergehäuse mit Ablasshahn / HP-filter housing with valve - 500 bar

			€/Stück €/piece	
4	HP-FI-LO-N-SET	3/8" NPS (F) - 1/4" NPS (M) - Edelstahl / Stainless steel	210,-	

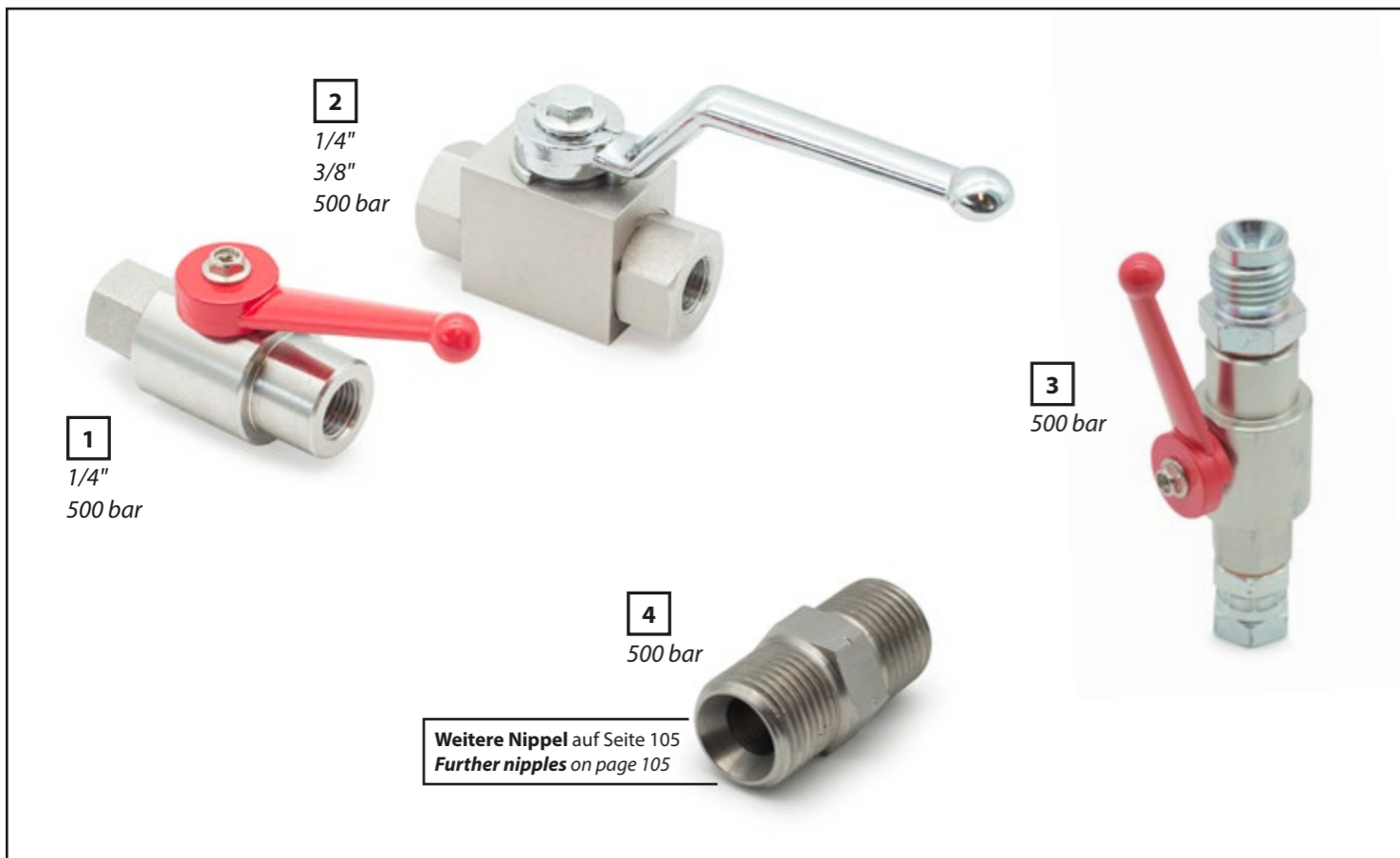

Pos.	Art.-Nr. Part-No.	Artikelbeschreibung Description	Listenpreis List price	Netto-Stückpreis bei Net unit price for
			€/Stück €/piece	

Hochdruck Kugelhähne / High pressure ball valves - 500 bar

1	23010-K-B	G 1/4" BSP - Klein / Small	46,-	
	23010-K-N	1/4" NPS - Klein / Small	28,-	
	23010-K-B-SS	G 1/4" BSP - Klein Edelstahl / Small stainless steel	74,-	
	23010-K-N-SS	1/4" NPS - Klein Edelstahl / Small stainless steel	50,-	

2	23010-G-B	G 1/4" BSP - Groß / Big	46,-	
	23015-G-N	3/8" NPS - Groß / Big	46,-	
	23010-G-B-SS	G 1/4" BSP - Groß Edelstahl / Big stainless steel	130,-	
	23010-G-N-SS	1/4" NPS - Groß Edelstahl / Big stainless steel	74,-	
	23015-G-B-SS	G 3/8" BSP - Groß Edelstahl / Big stainless steel	172,-	
	23015-G-N-SS	3/8" NPS - Groß Edelstahl / Big stainless steel	102,-	

3	CA5123	1/4" (F) x M20x2 (M) - A4000-A10000 - Rücklaufhahn / Return valve	68,-	
	CA5123-SS	1/4" (F) x M20x2 (M) - SS - A4000-A10000 - Rücklaufhahn / Return valve	100,-	

Hochdruck Verbindungsrippel / High pressure nipples - 500 bar

			€/Stück €/piece	
4	M1/4BXM1/4B	1/4" BSP (M) x 1/4" BSP (M)	7,-	
	M1/4NXM1/4N	1/4" NPS (M) x 1/4" NPS (M)		
	M1/4BXM1/4B-SS	1/4" BSP (M) x 1/4" BSP (M) - SS	16,-	
	M1/4NXM1/4N-SS	1/4" NPS (M) x 1/4" NPS (M) - SS		
	M3/8NXM3/8N	3/8" NPS (M) x 3/8" NPS (M)	7,-	
	M3/8NXM3/8N-SS	3/8" NPS (M) x 3/8" NPS (M) - SS	16,-	



Pos.	Art.-Nr. Part-No.	Artikelbeschreibung Description	Listenpreis List price	Netto-Stückpreis bei Net unit price for
			€/Stück €/piece	

Manometer / Gauges

1	MA-1/4-KPL	Manometeraufnahme / Connection for gauge - 1/4" (F) x 1/4" (M)	30,-	
	MA-1/4-KPL-SS	Manometeraufnahme / Connection for gauge - 1/4" (F) x 1/4" (M) - SS	56,-	
	MA-M16-KPL	Manometeraufnahme / Connection for gauge - M16x1.5 (F) x 1/4" (M)	30,-	
	MA-M16-KPL-SS	Manometeraufnahme / Connection for gauge - M16x1.5 (F) x 1/4" (M) - SS	56,-	

2	MANO-DI	Profildichtung für Manometer / Profile seal for gauge	1,40	
---	---------	---	------	--

3	MM50A	Ø50 axial	60,-	
---	-------	-----------	------	--

4	MM63R	Ø63 radial	28,-	
5	MM63A	Ø63 axial		

6	MK1/4KPL	Manometer Set kpl. / Gauge set cpl. - 1/4" (F) x 1/4" (M)	96,-	
	MK1/4KPL-SS	Manometer Set kpl. / Gauge set cpl. - 1/4" (F) x 1/4" (M) - SS	130,-	
	MKF16XM1/4	Manometer Set kpl. / Gauge set cpl. - M16 (F) x 1/4" (M)	96,-	

7	AC-REG-1	AirCombi Regler - 3/8" Innengewinde • 1/4" Außengewinde AirCombi regulator - 3/8" female thread • 1/4" male thread	150,-	
---	----------	---	-------	--

8	AL-REG-1	Airless Regler - 3/8" Innengewinde • 1/4" Außengewinde Airless regulator - 3/8" female thread • 1/4" male thread	90,-	
---	----------	---	------	--



Oberbehälter / Hoppers

Pos.	Art.-Nr. Part-No.	Artikelbeschreibung Description	Listenpreis List price €/Stück €/piece	Netto-Stückpreis bei Net unit price for
6 Liter				
1	520001-TRANS	Oberbehälter mit Deckel / Hopper with lid - M36x2 - transparent	52,-	
2	520001-EX	Oberbehälter mit Deckel / Hopper with lid - M36x2 - ATEX - schwarz / black	78,-	
3	RL-6	Rücklauf / Return pipe - M20x2	40,-	
	RL-6-W-LB	Rücklauf passend WAGNER / Return pipe fitting WAGNER		
4	520001-SS	Oberbehälter mit Deckel - Edelstahl - M36x2 Hopper with lid - stainless steel - M36x2	520,-	
30 Liter				
5	520030-M36	Oberbehälter mit Deckel / Hopper with lid - M36x2	240,-	
6	RL-30	Rücklauf / Return pipe	80,-	
Zubehör / Accessories				
7	ZR-R22	Zwischenring für Reduktion / Adapter for reduction - R22	16,-	
	ZR-1/2	Zwischenring für Reduktion / Adapter for reduction - 1/2"		
	DS-R22	Dichtscheibe für Reduktion / Seal plate for reduction - R22	10,-	
	DS-1/2	Dichtscheibe für Reduktion / Seal plate for reduction - 1/2"		
8	FI-HÜ	Filterscheibe 20 Maschen / Filter disc 20 mesh - D87 (6 ltr.)	2,80	
	FD-59-XXX-LB	Filterscheibe Edelstahl 20/50 Maschen - D59 (30 ltr.) Filter disc stainless steel 20/50 mesh - D59 (30 ltr.)	3,-	



Ansaugbögen Edelstahl / Suction adapters stainless steel

Pos.	Art.-Nr. Part-No.	Artikelbeschreibung Description	Listenpreis List price €/Stück €/piece	Netto-Stückpreis bei Net unit price for
1	SUC-L-1/2-SS	L-Ansaugbogen / L-suction adapter - M36x2 x 1/2"	50,-	
2	SUC-U-1/2-SS	U-Ansaugbogen / U-suction adapter - M36x2 x 1/2"	60,-	
	SUC-U-3/4-SS	U-Ansaugbogen / U-suction adapter - M36x2 x 3/4"		
	SUC-U-M36-SS	U-Ansaugbogen / U-suction adapter - M36x2 x M36x2		
3	SUC-180-3/4-SS	180°-Ansaugbogen / 180°-suction adapter - M36x2 x 3/4"	72,-	
	SUC-180-M36-SS	180°-Ansaugbogen / 180°-suction adapter - M36x2 x M36x2		
	SUC-180-M26-SS	180°-Ansaugbogen / 180°-suction adapter - M36x2 x M26x1,25		

Zubehör / Accessories

4	SUC-GASKET	Dichtung für Ansaugbogen Gasket for suction adapter	5,60	
5	SUC-ADAP-F1/2	Adapter für Ansaugbogen / Reduction for suction adapter - M36x2 x 1/2"	28,-	
	SUC-ADAP-F3/4	Adapter für Ansaugbogen / Reduction for suction adapter - M36x2 x 3/4"		
	SUC-ADAP-F1	Adapter für Ansaugbogen / Reduction for suction adapter - M36x2 x 1"		

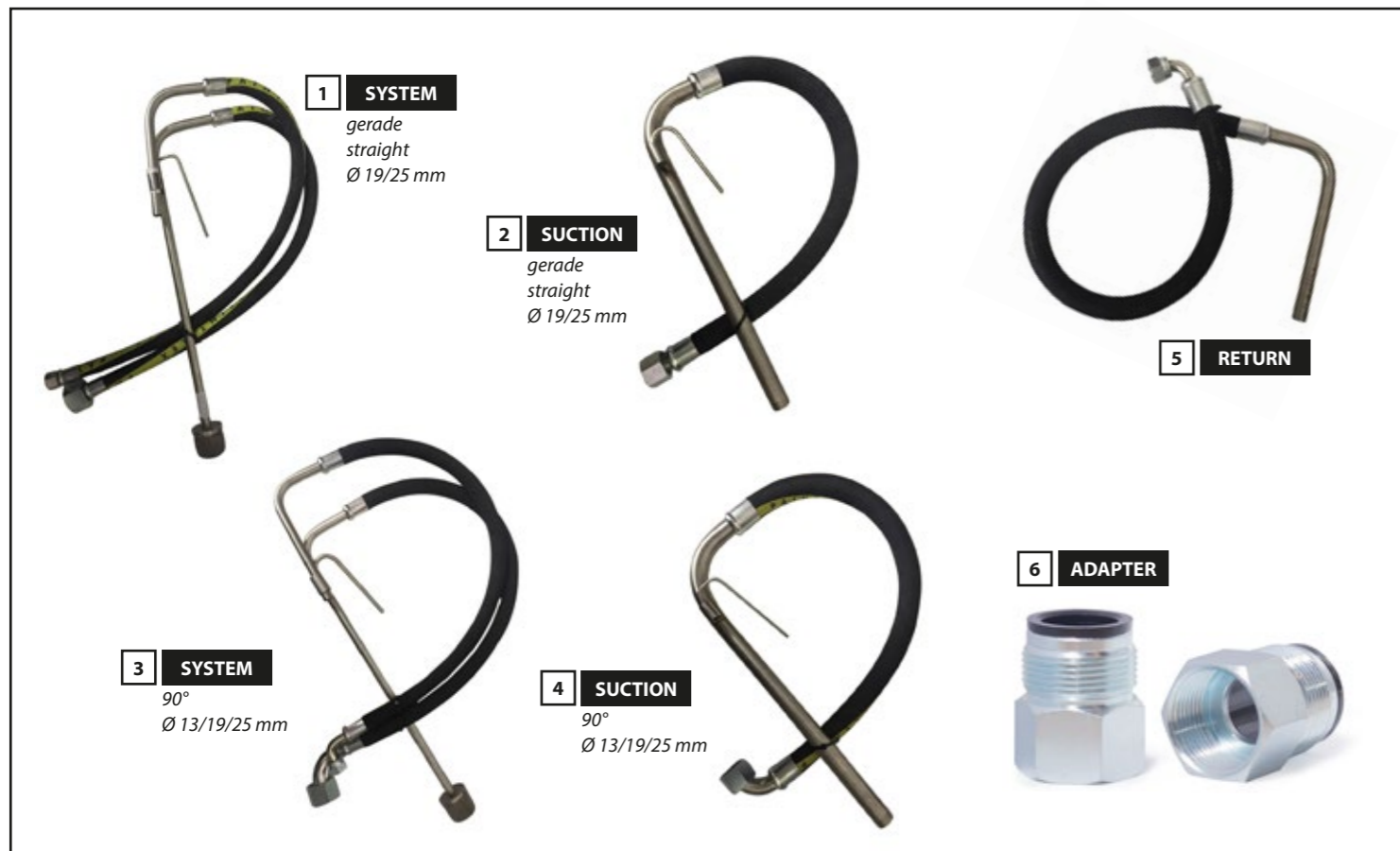

Flexible Ansaugsysteme / Flexible suction systems

Pos.	Art.-Nr. Part-No.	Artikelbeschreibung Description	Listenpreis List price	Netto-Stückpreis bei Net unit price for
			€/Stück €/piece	
Gerade - Edelstahl / Straight - stainless steel - M36x2				
1+2	NW19-VA-KPL	Ø19 Ansaugsystem kpl. / Suction system cpl. - Filter 1/2"	124,-	
	NW19AS-VA	Ø19 Ansaugschlauch / Suction hose	72,-	
	NW25-VA-KPL	Ø25 Ansaugsystem kpl. / Suction system cpl. - Filter M28	144,-	
	NW25AS-VA	Ø25 Ansaugschlauch / Suction hose	90,-	
90° - Edelstahl / 90° - stainless steel - M36x2				
3+4	NW13KPL-90	Ø13 Ansaugsystem kpl. / Suction system cpl. - Filter M15 - Stahl / Mild steel	134,-	
	NW13AS-90	Ø13 Ansaugschlauch / Suction hose - Stahl / Mild steel	72,-	
	NW19KPL-90-VA	Ø19 Ansaugsystem kpl. / Suction system cpl. - Filter 1/2"	144,-	
	NW19AS-90-VA	Ø19 Ansaugschlauch / Suction hose	80,-	
	NW25KPL-90-VA	Ø25 Ansaugsystem kpl. / Suction system cpl. - Filter M28	164,-	
	NW25AS-90-VA	Ø25 Ansaugschlauch / Suction hose	100,-	
Rücklaufschläuche / Return hoses - M20x2				
5	NW-RS-VA	gerade / straight - Edelstahl / Stainless steel	44,-	
	NW-RS-90-VA	90° - Edelstahl / Stainless steel	52,-	
Adapter				
6	SUC-ADAP-F1/2	Adapter für Ansaugbogen / Reduction for suction adapter - M36x2 x 1/2"	28,-	
	SUC-ADAP-F3/4	Adapter für Ansaugbogen / Reduction for suction adapter - M36x2 x 3/4"		
	SUC-ADAP-F1	Adapter für Ansaugbogen / Reduction for suction adapter - M36x2 x 1"		



Ansaugfilter / Suction filters

Pos.	Art.-Nr. Part-No.	Artikelbeschreibung Description	Listenpreis List price	Netto-Stückpreis bei Net unit price for
			€/Stück €/piece	
1	AF-H-15-XXX	15 Maschen / 15 mesh - 1/2" / 3/4" / 1" / M28 / M38 - Hexagon	24,-	
	AF-H-30-M28	30 Maschen / 30 mesh - M28 - Hexagon		
2	ANF-R-15-XXX	15 Maschen / 15 mesh - 1/2" / 3/4" / 7/8" / 1" / M15 / M28 - Round	12,-	
	ANF-R-15-3/4-UNF	15 Maschen / 15 mesh - 3/4" UNF - Round		
	ANF-R-30-XXX	30 Maschen / 30 mesh - 1/2" / 3/4" / 1" / M15 / M28 - Round		
	ANF-R-60-XXX	60 Maschen / 60 mesh - 1/2" / M15 - Round		
3	ANF-MINI-1/2	30 Maschen / 30 mesh - 1/2"	12,-	
	ANF-MINI-M15	30 Maschen / 30 mesh - M15		
4	2011101	grob / rough - Ø 28	25,-	
	2011102	fein / smooth - Ø 28		
	2011103	grob / rough - Ø 22		
	2011104	fein / smooth - Ø 22		
5	FG-KPL-M15-LB	Filterglocke kpl. / Filter housing cpl. - M15x1	10,-	
	FG-KPL-1/2-LB	Filterglocke kpl. / Filter housing cpl. - 1/2"		

ELECTRIC MIXER & SMOOTHING BLADES



Art.-Nr. / Part-No.
MA-MIX-1600

MASPRA Rührwerk

- 2 Geschwindigkeitsstufen
- Stufe I: 250 - 500 rpm
- Stufe II: 400 - 800 rpm
- 1.600 Watt
- Rührflügel Ø 140 mm

MASPRA Mixer

- Dual speed
- Speed I: 250 - 500 rpm
- Speed II: 400 - 800 rpm
- 1.600 Watt
- Paddle Ø 140 mm

180,- € Listenpreis
List price



Art.-Nr. / Part-No.
MA-MIX-1600#6

MASPRA Rührstab
komplett inklusive Rührflügel

- 590 mm
- M14 x 2.0

MASPRA stirring rod
complete with propeller

- 590 mm
- M14 x 2.0

24,- € Listenpreis
List price

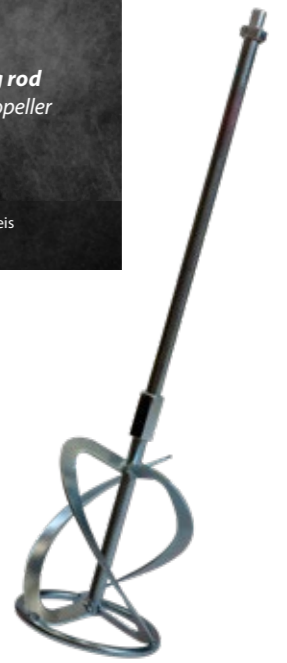

Art.-Nr. / Part-No.
MA-SMOOTH-SET

MASPRA Flächenspachtel

- Aluminium
- 3 Längen: 30 cm, 55 cm und 80 cm
- Inklusive Ersatzmesser
- Teleskopstange
- Aufbewahrungskoffer

MASPRA smoothing blades

- Aluminum
- 3 lengths: 30 cm, 55 cm and 80 cm
- Including replacement blades
- Telescopic rod
- Storage case

170,- € Listenpreis
List price



SPRAY LANCES BUILDING PROTECTION

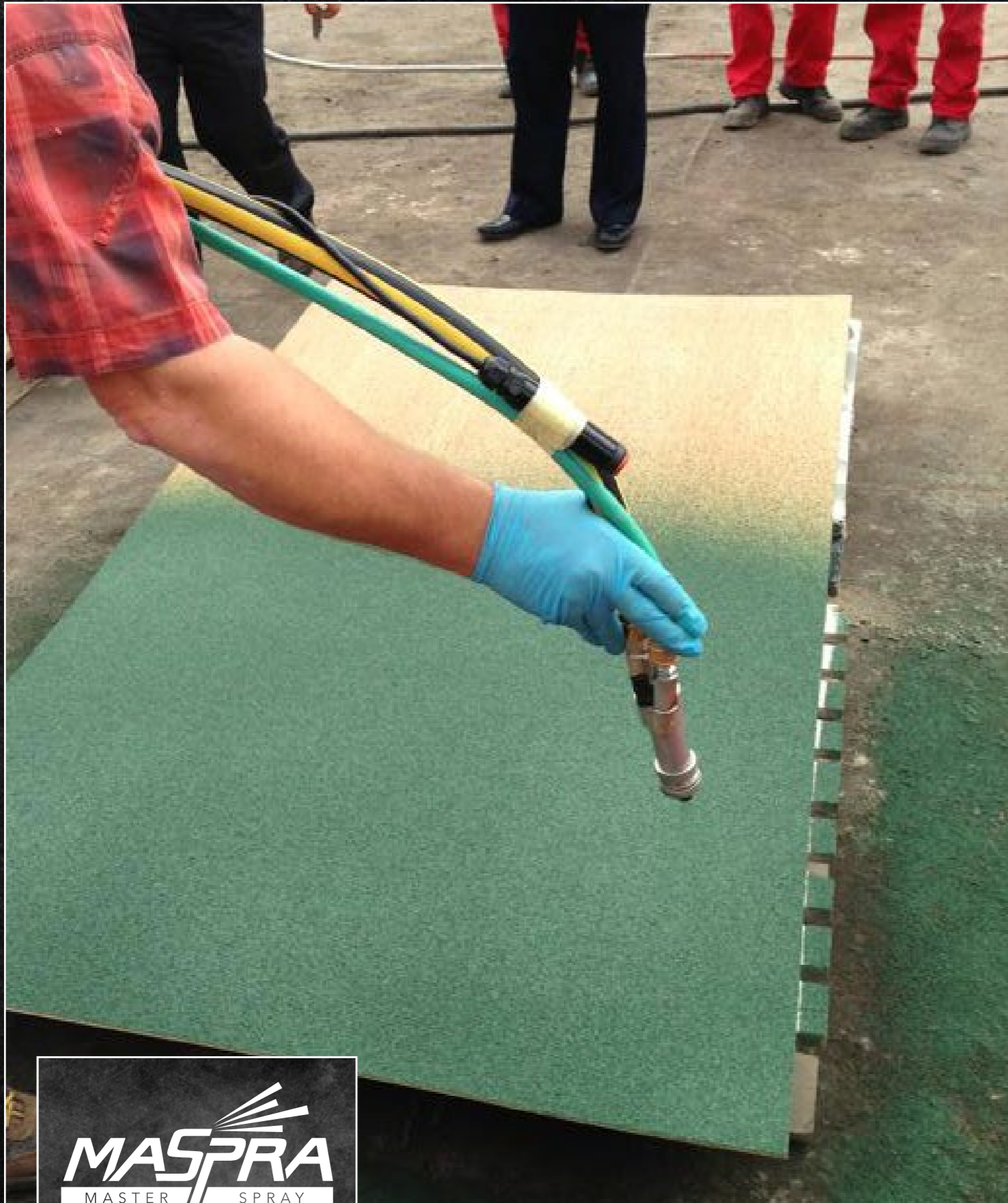

Art.-Nr. / Part-No.
MA-SPL-100

MASPRA Spritzlanze
komplett mit 6.5 mm Düse

MASPRA Spray lance
complete with 6.5 mm nozzle

240,- € Listenpreis
List price



Art.-Nr. / Part-No.
MA-SPL-330

MASPRA Spritzlanze
lange Ausführung - 330 mm
komplett mit 6.5 mm Düse

MASPRA Spray lance
long version - 330 mm
complete with 6.5 mm nozzle

260,- € Listenpreis
List price



Art.-Nr. / Part-No.
MA-786xx

Düse für Spritzlanze
Nozzle for spray lance

4.5 mm MA-78624
6.5 mm MA-78623
8.5 mm MA-78622
10.5 mm MA-78621

24,- € Listenpreis
List price



Art.-Nr. / Part-No.
MA-78625

Flachstrahl-Düse
Flat nozzle

34,- € Listenpreis
List price



MASPRA

MASTER SPRAY



Zuverlässig. Hochwertig. Individuell.
Preisgünstig.

Wir produzieren CE und ATEX zerti-
fizierte hochdruck Airless Pistolen für
die Farbspritztechnik auf höchstem
Qualitätsniveau.

Leicht, handlich, robust: Das ist MASPPRA!

*Reliable. High-quality. Customized.
Economic.*

*We produce CE and ATEX certified high
pressure Airless guns for paint spraying
at the highest quality level.*

Lightweight, handy, robust: This is MASPPRA!

OPTION PRIVATE LABEL

Option für Großkunden: 100% private label!
Logo, Farbe und Gravur können bei MASPPRA
Produkten individuell abgestimmt werden,
ebenso der Lieferumfang sowie das gesamte
Marketingpaket.

Quantity buy option: 100% private label!

*Logo, color and engraving of MASPPRA products,
can be individually customized, as well as the
scope of delivery and the whole marketing package.*



MASTER QUALITY AIRLESS GUNS

HIGH PRESSURE AIRLESS SPRAY GUNS



Art.-Nr. / Part-No.
MA-AG500
7/8"
MA-AG500-F
11/16"

**MASPRA Airless Pistole
AG500 inkl. Düsenhalter**
• 500 bar
• 3 mm Kugel
• 7/8" oder 11/16" Diffuser
• 1/4" Drehgelenk

**MASPRA Airless gun
AG500 incl. tip base**
• 500 bar
• 3 mm ball
• 7/8" or 11/16" diffusor
• 1/4" swivel

150,- € Listenpreis
List price

Art.-Nr. / Part-No.
MA-700x-SS

**M14x1.0 - 500 bar
Drehgelenk - Edelstahl
Swivel - stainless steel**

1/4" NPS.....G-7004-SS
M16x1.5.....G-7005-SS

58,- € Listenpreis
List price



Art.-Nr. / Part-No.
MA-AG500-L
7/8"
MA-AG500-L-F
11/16"

**MASPRA Airless Pistole
AG500-L inkl. Düsenhalter**
• 500 bar
• 5 mm Kugel
• 7/8" oder 11/16" Diffuser
• 1/4" Drehgelenk

**MASPRA Airless gun
AG500-L incl. tip base**
• 500 bar
• 5 mm ball
• 7/8" or 11/16" diffusor
• 1/4" swivel

160,- € Listenpreis
List price





Art.-Nr. / Part-No.
MA-AG250-LIGHT

- MASPRA Airless Pistole
AG250-LIGHT**
- 250 bar
 - 5 mm Kugel
 - 7/8" Diffuser
 - 1/4" Drehgelenk

- MASPRA Airless gun
AG250-LIGHT**
- 250 bar
 - 5 mm ball
 - 7/8" diffusor
 - 1/4" swivel

96,- € Listenpreis
List price



Art.-Nr. / Part-No.
MA-AG-S

- MASPRA Airless Pistole
AG-S**
- 345 bar
 - 4 mm Kugel
 - 7/8" Diffuser
 - 1/4" Anschlussgewinde

- MASPRA Airless gun
AG-S**
- 345 bar
 - 4 mm ball
 - 7/8" diffusor
 - 1/4" connection thread

160,- € Listenpreis
List price



Art.-Nr. / Part-No.
MA-AG-X7

- MASPRA Airless Pistole
AG-X7**
- 500 bar
 - 4 mm Kugel
 - 7/8" Diffuser
 - 1/4" Drehgelenk

- MASPRA Airless gun
AG-X7**
- 500 bar
 - 4 mm ball
 - 7/8" diffusor
 - 1/4" swivel

250,- € Listenpreis
List price



Art.-Nr. / Part-No.
AG500-G-G-B
7/8"

AG500-G-B
11/16"

- Airless Pistole AG500**
- 500 bar
 - 3 mm Kugel
 - 7/8" oder 11/16" Diffuser
 - 1/4" Drehgelenk

- Airless gun AG500**
- 500 bar
 - 3 mm ball
 - 7/8" or 11/16" diffusor
 - 1/4" swivel

130,- € Listenpreis
List price



Art.-Nr. / Part-No.
MA-AG-XXL-G

MASPRA Airless Pistole AG-XXL
 • 500 bar
 • 7 mm Kugel
 • 7/8" Diffuser
 • 1/2" Drehgelenk

MASPRA Airless gun AG-XXL
 • 500 bar
 • 7 mm ball
 • 7/8" diffuser
 • 1/2" swivel

340,- € Listenpreis
List price



Art.-Nr. / Part-No.
MA-AG250-POLE

MASPRA Airless Pistole AG250-POLE
 • 250 bar
 • 5 mm Kugel
 • 7/8" Diffuser
 • 1/4" Drehgelenk

MASPRA Airless gun AG250-POLE
 • 250 bar
 • 5 mm ball
 • 7/8" diffuser
 • 1/4" swivel

110,- € Listenpreis
List price

Art.-Nr. / Part-No.
MA-AG190

MASPRA Airless Pistole AG190
 • 250 bar
 • 5 mm Kugel
 • 7/8" Diffuser
 • 3/8" Drehgelenk

MASPRA Airless gun AG190
 • 250 bar
 • 5 mm ball
 • 7/8" diffuser
 • 3/8" swivel

186,- € Listenpreis
List price



Art.-Nr. / Part-No.
MA-AG250-POLE-KIT

MASPRA Airless Kit "Pole"
 • Stabpistole 250 bar
 • 1 m Düsenverlängerung
 • Master shut-off Ventil
 • Halter & Düse - MASPRA 517

MASPRA Airless kit "Pole"
 • Pole gun 250 bar
 • 1 m extension
 • Master shut-off valve
 • Base & tip - MASPRA 517

280,- € Listenpreis
List price



Inklusive



Inklusive



Inklusive



MASPRA. ALUMINIUM.

Düsenverlängerungen aus Aluminium.

- Erhältlich in 15/30/50/75/100 cm
- 11/16" oder 7/8" Anschlussgewinde
- Bis max. 250 bar

Pole extensions made of aluminum.

- Available in 15/30/50/75/100 cm
- 11/16" or 7/8" connection thread
- Up to max. 250 bar



Art.-Nr. Part-No.	Artikelbeschreibung Description	Listenpreis List price	Netto-Stückpreis bei Net unit price for
		€/Stück €/piece	
MA-63-150-F	15 cm - 11/16"	22,-	
MA-63-150-G	15 cm - 7/8"		
MA-63-300-F	30 cm - 11/16"	22,-	
MA-63-300-G	30 cm - 7/8"		
MA-63-500-F	50 cm - 11/16"	24,-	
MA-63-500-G	50 cm - 7/8"		
MA-63-750-F	75 cm - 11/16"	28,-	
MA-63-750-G	75 cm - 7/8"		
MA-63-1000-F	100 cm - 11/16"	32,-	
MA-63-1000-G	100 cm - 7/8"		

Mindestabnahme:
5 Stk. Mix & Match
Minimum order quantity:
5 pcs. mix & match



Art.-Nr. / Part-No.
MA-63-AH-x

MASPRA Kniegelenk
• Aluminium
• max. 250 bar

MASPRA anglehead
• aluminum
• max. 250 bar

11/16" MA-63-AH-F
7/8" MA-63-AH-G

16,- € Listenpreis
List price

Art.-Nr. / Part-No.
MA-SOV-G

**MASPRA Master Shot
Shut-off Ventil**
• 180° drehbar
• max. 248 bar
• 7/8" Anschlussgewinde

**MASPRA Master Shot
Shut-off valve**
• 180° swivel
• max. 248 bar
• 7/8" connection thread

84,- € Listenpreis
List price



Art.-Nr. / Part-No.
MA-LINE-SPRAY

MASPRA LineSpray
• Spritzhilfe für Kanten
• max. 250 bar
• 7/8" Anschlussgewinde

MASPRA LineSpray
• Spray guide painting tool
• max. 250 bar
• 7/8" connection thread

24,- € Listenpreis
List price





Pos.	Art.-Nr. Part-No.	Artikelbeschreibung Description	Listenpreis List price	Netto-Stückpreis bei Net unit price for
			€/Stück €/piece	

Adapter - Hochdruck / High pressure - 500 bar

	Außengewinde / Male	Innengewinde / Female	Edelstahl / Stainless steel		
1	M1/4NxF16	1/4" NPS	M16x1.5		8,-
	M1/4NxF16-SS	1/4" NPS	M16x1.5	✓	16,-
	M1/4Nx3/8N	1/4" NPS	3/8" NPS		8,-
	M1/4Nx3/8N-SS	1/4" NPS	3/8" NPS	✓	16,-
	M16xF1/4N-SS	M16x1.5	1/4" NPS	✓	16,-
	M16xF3/8N	M16x1.5	3/8" NPS		8,-
	M3/8Nx3/8N	3/8" NPS	1/4" NPS		8,-
	M3/8Nx3/8N-SS	3/8" NPS	1/4" NPS	✓	16,-
	M1/2Nx3/8N-SS	1/2" NPS	3/8" NPS	✓	27,-

2	W34041-LB	Adapter 1/4" IG (F) - M16x1.5 (M) - Edelstahl / Stainless steel	14,40	
---	-----------	---	-------	--

Hochdruckdrehgelenke - Kugelgelagert - High pressure swivels - Ball bearing

3	G-7009-SS	1/4" NPS (F) x 1/4" NPS (M) - Edelstahl / Stainless steel - 500 bar	58,-	
	G-7012-SS	1/4" NPS (F) x 3/8" NPS (M) - Edelstahl / Stainless steel - 500 bar		
	G-7024-SS	3/8" NPS (F) x 3/8" NPS (M) - Edelstahl / Stainless steel - 500 bar		

Adapter diffusor

4	MA-32-1/4-7/8	7/8" (F) x 1/4" NPS (M) - Edelstahl / Stainless steel	24,-	
5	M7/8XF11/16	7/8" (M) x 11/16" (F)	22,-	



Pos.	Art.-Nr. Part-No.	Artikelbeschreibung Description	Listenpreis List price	Netto-Stückpreis bei Net unit price for
			€/Stück €/piece	

Injektion / Injection

1	INJECT11/16	Verpressschlauch inkl. Mundstück ohne Manometer - 11/16" Injection hose incl. jaw grip nozzle without gauge - 11/16"	44,-	
	INJECT7/8	Verpressschlauch inkl. Mundstück ohne Manometer - 7/8" Injection hose incl. jaw grip nozzle without gauge - 7/8"		

2	INJECT11/16 MANO	Verpressschlauch inkl. Mundstück und Manometer - 11/16" Injection hose incl. jaw grip nozzle and gauge - 11/16"	134,-	
	INJECT7/8 MANO	Verpressschlauch inkl. Mundstück und Manometer - 7/8" Injection hose incl. jaw grip nozzle and gauge - 7/8"		

	LA07725840	Flex. Verpressschlauch / Flex. inject hose - 25 cm	12,-	
--	------------	--	------	--

3	LA01840	4-Backen Mundstück / 4-jaw grip nozzle	6,40	
---	---------	--	------	--

4	MM50A	Manometer - lösemittelbeständiges Sicherheitsglas - Ø 50 axial Gauge - solvent resistant safety glass - Ø 50 axial	60,-	
---	-------	---	------	--

5	MANO-DI	Profildichtung für Manometer / Profile seal for gauge	1,40	
---	---------	---	------	--

6	MA-AG250-LIGHT	1/4" - 7/8" - 250 bar	96,-	
---	----------------	-----------------------	------	--

Z-Drehgelenk / Z-swivel - 350 bar

7	HP-Z-1/4-350	Kupplung verzinkt, 3-fach drehbar - 1/4" (M) x 1/4" (F) Coupling zinc-plated, triple swivel - 1/4" (M) x 1/4" (F)	90,-	
---	--------------	--	------	--

HIGH PRESSURE INNER TUBE COATING



Rundstrahldüsenystem
RST-L separat erhältlich
Round jet tip system
RST-L separately available

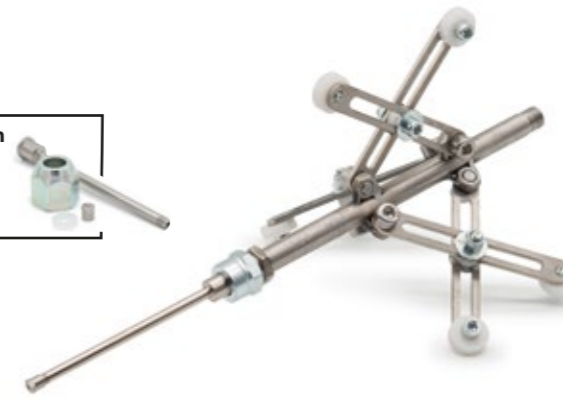

Art.-Nr. / Part-No.
MA-PNEU-MINI

**MASPRA Mini
Rohrinnenbeschichtung
ohne Düsenystem**
• Ø 50-250 mm
• 11/16" Diffuser
• 1/4" Schlauchanschluss

**MASPRA Mini
inner tube coating
without tip system**
• Ø 50-250 mm
• 11/16" diffusor
• 1/4" hose connection

240,- € Listenpreis
List price

Art.-Nr. / Part-No.
MA-PNEU-BIG

**MASPRA Big
Rohrinnenbeschichtung
ohne Düsenystem**
• Ø 250-750 mm
• 11/16" Diffuser
• 1/4" Schlauchanschluss

**MASPRA Mini
inner tube coating
without tip system**
• Ø 250-750 mm
• 11/16" diffusor
• 1/4" hose connection

3.000,- € Listenpreis
List price

Düsenysteme und Verlängerungen
separat erhältlich
Tip systems and extensions
separately available



HIGH PRESSURE AIRCOMBI SPRAY GUNS



Art.-Nr. / Part-No.
MA-M140-R

**MASPRA AirCombi Pistole
M140-R - Version Wagner**

- 250 bar
- Inkl. Düse "W" - 411
- Langes Filtergehäuse
- Rote Luftkappe

**MASPRA AirCombi gun
M140-R - Version Wagner**

- 250 bar
- Incl. nozzle "W" - 411
- Long filter housing
- Red AirCap

480,- € Listenpreis
List price



Art.-Nr. / Part-No.
MA-M140-B

**MASPRA AirCombi Pistole
M140-B - Version Wagner**

- 250 bar
- Inkl. Düse "W" - 411
- Langes Filtergehäuse
- Blaue Luftkappe

**MASPRA AirCombi gun
M140-B - Version Wagner**

- 250 bar
- Incl. nozzle "W" - 411
- Long filter housing
- Blue AirCap

480,- € Listenpreis
List price



Art.-Nr. / Part-No.
MA-M150

**MASPRA AirCombi Pistole
M150 - Version MT-U**

- 250 bar
- Inkl. Wendedüse
MASPRA FineFinish 410
- Langes Filtergehäuse

**MASPRA AirCombi gun
M150 - Version MT-U**

- 250 bar
- Incl. reversible tip
MASPRA FineFinish 410
- Long filter housing

480,- € Listenpreis
List price



Art.-Nr. / Part-No.
M110-S-O-R
 Filter Optima
M110-S-L-R
 Filter lang / long

AirCombi Pistole M110 - Version Optima 2000

- 250 bar
- Inkl. Düse "Rund" - 428 und Luftkappe
- Kurzes oder langes Filtergehäuse

AirCombi gun M110 - Version Optima 2000

- 250 bar
- Incl. nozzle "round" - 428 and AirCap
- Short or long filter housing

500,- € Listenpreis
List price



Art.-Nr. / Part-No.
M120-S-L-K

AirCombi Pistole M120 - Version Kremlin

- 250 bar
- Inkl. Düse "KR" - 06.094 und Luftkappe
- Langes Filtergehäuse

AirCombi gun M120 - Version Kremlin

- 250 bar
- Incl. nozzle "KR" - 06.094 and AirCap
- Long filter housing

500,- € Listenpreis
List price



Art.-Nr. / Part-No.
M110-S-L-H

AirCombi Pistole M110 - Version Optima 2100

- 250 bar
- Inkl. Düse "sechskant" - 428 und Luftkappe
- Langes Filtergehäuse

AirCombi gun M110 - Version Optima 2100

- 250 bar
- Incl. nozzle "hexagon" - 428 and AirCap
- Long filter housing

500,- € Listenpreis
List price



Art.-Nr. / Part-No.
M140-S-L-W-R
 Rot / Red
M140-S-L-W-B
 Blau / Blue

AirCombi Pistole M140 - Version Wagner

- 250 bar
- Inkl. Düse "W" - 411
- Langes Filtergehäuse
- Blaue oder rote Luftkappe

AirCombi gun M140 - Version Wagner

- 250 bar
- Incl. nozzle "W" - 411
- Long filter housing
- Blue or red AirCap

520,- € Listenpreis
List price



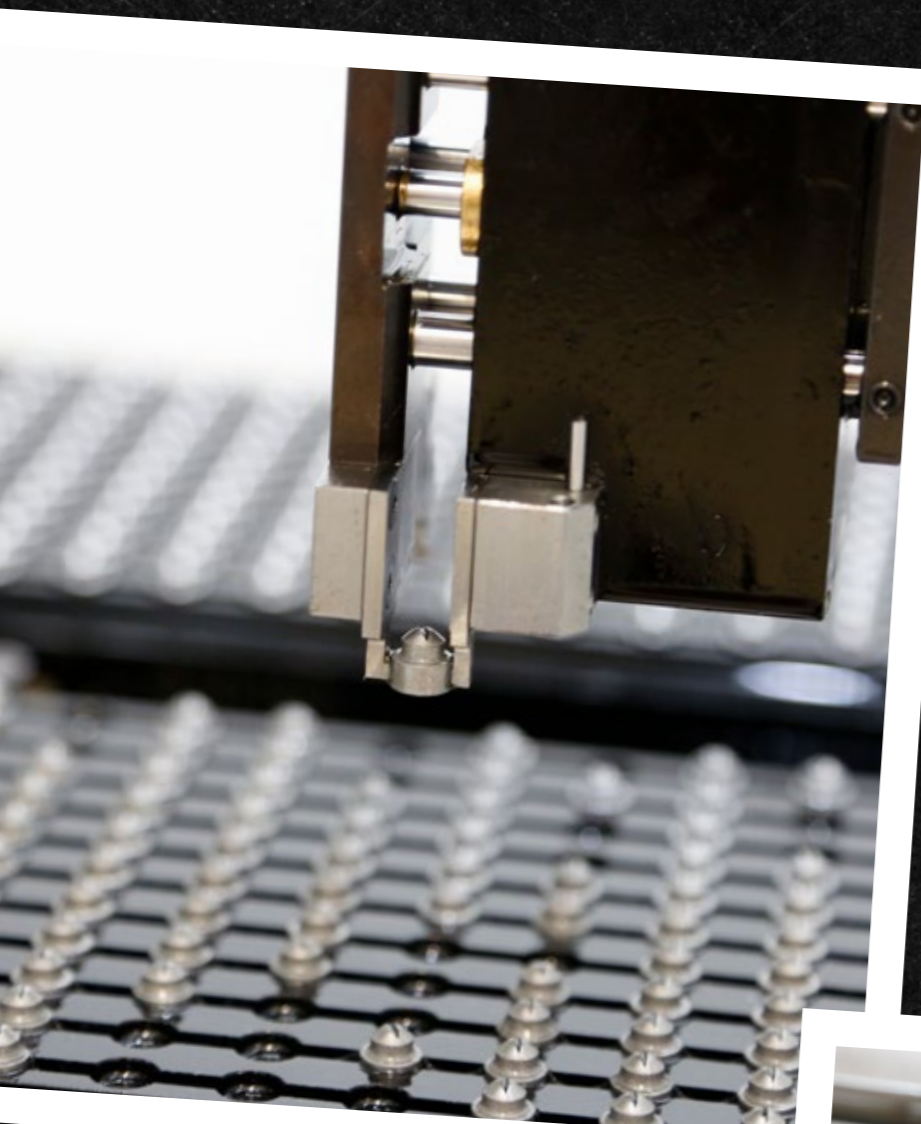

**Eigene Düsenproduktion.
Made in Germany.**

An unserem Standort in Friedrichshafen produzieren wir Wolfram Carbid **Hartmetall Düsen** für den Einsatz im Bereich der **Spritztechnik**.

Eingebaut in **gehärtete Edelstahlträger**, bieten MASPRA Düsen sowohl für das **Airless**, als auch für das **AirCombi** Spritzverfahren, die beste Lösung.

**Own tip production.
Made in Germany.**

On our site in Friedrichshafen, we produce **tungsten carbide tips** for spraying technology.

Mounted into **hardened stainless steel** housings, MASPRA tips are the best solution for **Airless & AirCombi** application.

Nichts dem Zufall überlassen.

Durch einen **vollautomatischen Schleifprozess**, sowie computergesteuerte Messungen und **Qualitätsprüfungen**, garantieren wir eine gleichbleibende **Spitzenqualität**.

Perfektes Spritzbild bei langer Lebensdauer:
Das ist MASPRA!

Focused on Quality.

Through a **fully automatic grinding process**, as well as computer-controlled measurements and **quality checks**, we guarantee a consistent **top product**.

Perfect spray pattern with a long service life:
This is MASPRA!



MASTER QUALITY SPRAY TIPS

 **OPTION**
PRIVATE LABEL

MADE IN 
GERMANY

HIGH PRESSURE AIRLESS FLAT JET TIPS

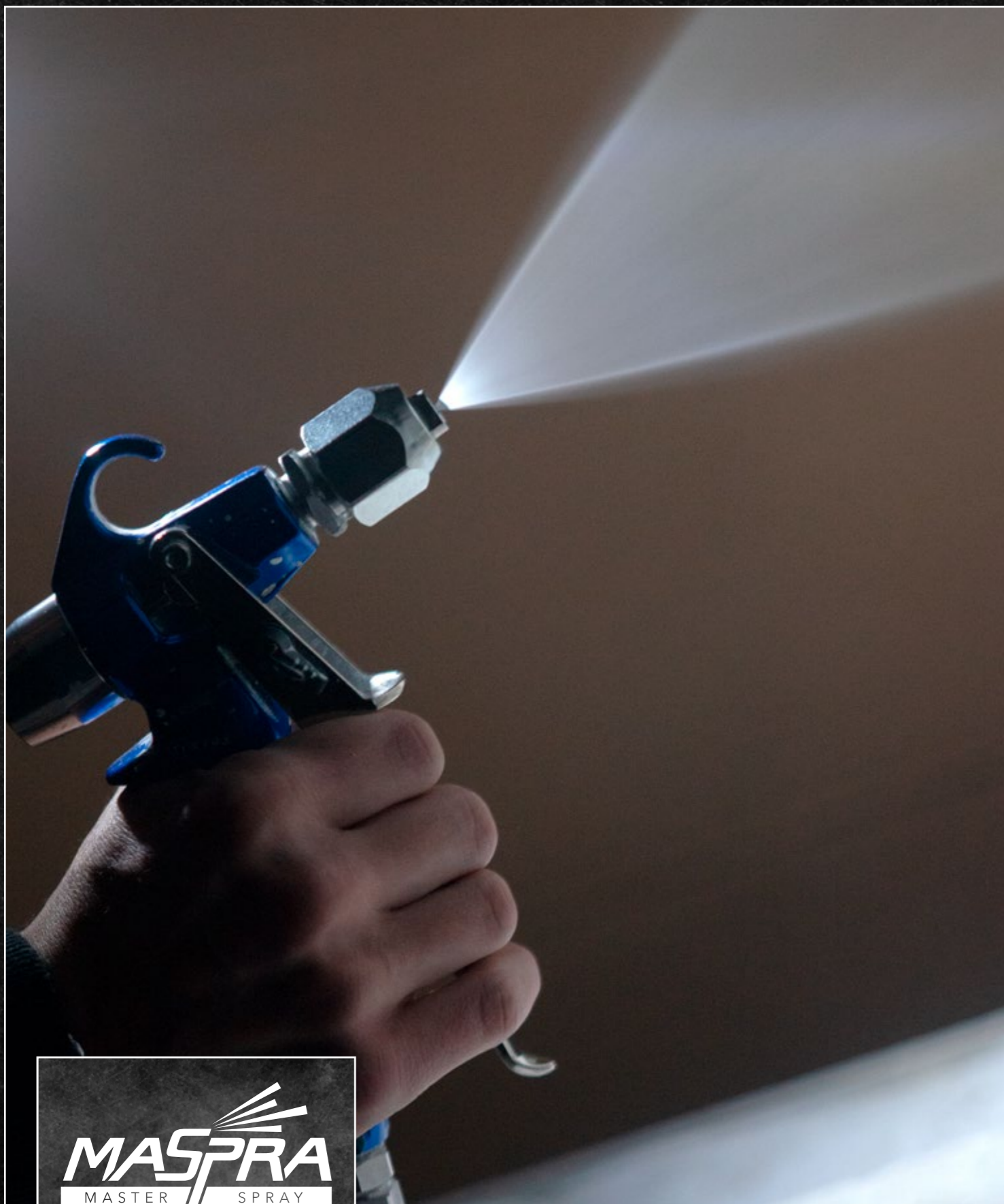

Art.-Nr. / Part-No.
MA-163-xxx-FF-SS

**MASPRA Airless
Flachstrahldüse Lang**
• Mit Vorzerstäuber
• Edelstahlgehäuse
• Inklusive Dichtung

**MASPRA Airless
Flat jet tip long**
• With preorifice
• Stainless steel housing
• Including seal

44,- € Listenpreis
List price



OPTION PRIVATE LABEL **MADE IN GERMANY** Eigene Düsenproduktion
Own tip production

Art.-Nr. / Part-No.
MA-93-xxx-SS
Standard

**MASPRA MA-Version
Flachstrahldüse kurz**
• Edelstahlgehäuse
• Standard

**MASPRA MA-Version
Flat jet tip short**
• Stainless steel housing
• Standard

22,- € Listenpreis
List price

Art.-Nr. / Part-No.
MA-93-xxx-FF-SS
FineFinish

**MASPRA MA-Version
Flachstrahldüse kurz**
• Edelstahlgehäuse
• Mit Vorzerstäuber

**MASPRA MA-Version
Flat jet tip short**
• Stainless steel housing
• With preorifice

24,- € Listenpreis
List price



MASPRA
SPRAY PARAMETER

Entspricht in Durchflussmenge und Spritzstrahlwinkel dem Durchschnitt der bekannten Herstellermodelle.

Matches the flow rate and spray angle parameters of the average of well-known manufacturer models.

OPTION PRIVATE LABEL **MADE IN GERMANY** Eigene Düsenproduktion
Own tip production



Art.-Nr. / Part-No.
MA-93-W-xxx-SS
Standard

**MASPRA W-Version
Flachstrahldüse kurz**
• Edelstahlgehäuse
• Standard

**MASPRA W-Version
Flat jet tip short**
• Stainless steel housing
• Standard

24,- € Listenpreis
List price

Art.-Nr. / Part-No.
MA-93-W-xxx-FF-SS
FineFinish

**MASPRA W-Version
Flachstrahldüse kurz**
• Edelstahlgehäuse
• Mit Vorzerstäuber

**MASPRA W-Version
Flat jet tip short**
• Stainless steel housing
• With preorifice

26,- € Listenpreis
List price

WAGNER
SPRAY PARAMETER

Entspricht in Durchflussmenge und Spritzstrahlwinkel den Parametern der WAGNER Standarddüsen.

Matches the flow rate and spray angle parameters of the WAGNER standard tips.

OPTION
PRIVATE LABEL

MADE IN GERMANY

Eigene **Düsenproduktion**
Own **tip production**



Art.-Nr. / Part-No.
MA-93-GR-xxx-SS
Standard

**MASPRA GR-Version
Flachstrahldüse kurz**
• Edelstahlgehäuse
• Standard

**MASPRA GR-Version
Flat jet tip short**
• Stainless steel housing
• Standard

24,- € Listenpreis
List price

Art.-Nr. / Part-No.
MA-93-GR-xxx-FF-SS
FineFinish

**MASPRA GR-Version
Flachstrahldüse kurz**
• Edelstahlgehäuse
• Mit Vorzerstäuber

**MASPRA GR-Version
Flat jet tip short**
• Stainless steel housing
• With preorifice

26,- € Listenpreis
List price

GRACO
SPRAY PARAMETER

Entspricht in Durchflussmenge und Spritzstrahlwinkel den Parametern der GRACO Standarddüsen.

Matches the flow rate and spray angle parameters of the GRACO standard tips.

OPTION
PRIVATE LABEL

MADE IN GERMANY

Eigene **Düsenproduktion**
Own **tip production**



Art.-Nr. / Part-No.
MA-93-TI-xxx-SS
Standard

**MASPRA TI-Version
Flachstrahldüse kurz**
• Edelstahlgehäuse
• Standard

**MASPRA TI-Version
Flat jet tip short**
• Stainless steel housing
• Standard

24,- € Listenpreis
List price

Art.-Nr. / Part-No.
MA-93-TI-xxx-FF-SS
FineFinish

**MASPRA TI-Version
Flachstrahldüse kurz**
• Edelstahlgehäuse
• Mit Vorzerstäuber

**MASPRA TI-Version
Flat jet tip short**
• Stainless steel housing
• With preorifice

26,- € Listenpreis
List price

TITAN
SPRAY PARAMETER

Entspricht in Durchflussmenge und Spritzstrahlwinkel den Parametern der TITAN Standarddüsen.

Matches the flow rate and spray angle parameters of the TITAN standard tips.

OPTION
PRIVATE LABEL

MADE IN GERMANY

Eigene **Düsenproduktion**
Own **tip production**

Art.-Nr. / Part-No.
MA-NUT-11/16

MASPRA Überwurfmutter
• 11/16"
• Normalstahl Variante

MASPRA wrap nut
• 11/16"
• Normal steel version

6,- € Listenpreis
List price

Art.-Nr. / Part-No.
MA-NUT-7/8

MASPRA Überwurfmutter
• 7/8"
• Normalstahl

MASPRA wrap nut
• 7/8"
• Normal steel

8,- € Listenpreis
List price

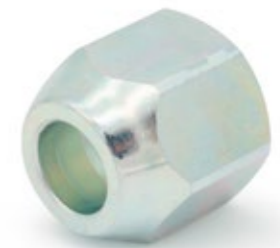

Art.-Nr. / Part-No.
MA-NUT-11/16-SS

• Edelstahl Variante
• Stainless steel version

8,- € Listenpreis
List price



Art.-Nr. / Part-No.
W43052-LB

Dichtung für Standarddüsen

Seal for standard tips

1,20 € Listenpreis
List price



HIGH PRESSURE AIRLESS ROUND JET TIPS



1 ROUND
inkl. Vorzerstäuber
incl. preorifice



2 LANCE
Hohlraumlanze kpl.
Cavity lance cpl.



3 FLEX-HOSE
Verschiedene Längen möglich
Various lengths possible



4 ADAPTER



5 E-STATIC
Rundstrahldüse inkl. E-Statik Aufnahme
Round jet tip incl. e-static support

Eigene Düsenproduktion
Own tip production

MADE IN GERMANY

Rundstrahl / Round jet

Pos.	Art.-Nr. Part-No.	Artikelbeschreibung Description	Listenpreis List price €/Stück €/piece	Netto-Stückpreis bei Net unit price for
------	----------------------	------------------------------------	---	--

Hohlraumkonservierung / Cavity preservation

1	MA-RST-11	Rundstrahldüse inkl. Vorzerstäuber / Round jet tip incl. preorifice R11 - 0.16 Ltr./min. (100 bar)	64,-	
	MA-RST-15	Rundstrahldüse inkl. Vorzerstäuber / Round jet tip incl. preorifice R15 - 0.38 Ltr./min. (100 bar)		
	MA-RST-16	Rundstrahldüse inkl. Vorzerstäuber / Round jet tip incl. preorifice R16 - 0.43 Ltr./min. (100 bar)		
2	MA-RST-L-120-Rxx-F	Hohlraumlanze 120 mm inkl. Düse nach Wahl R11,R15 oder R16 und Überwurfmutter 11/16" Cavity lance 120 mm incl. tip of your choice R11, R15 or R16 and wrap nut 11/16"	120,-	
	MA-RST-L-120-Rxx-G	Hohlraumlanze 120 mm inkl. Düse nach Wahl R11,R15 oder R16 und Überwurfmutter 7/8" Cavity lance 120 mm incl. tip of your choice R11, R15 or R16 and wrap nut 7/8"		
3	MA-T-1/8-08-RST	Flexibler Schlauch für Hohlraumkonservierung - 80 mm inkl. Aufnahme für Rundstrahldüse (Düse RST-xx separat erhältlich) Flexible hose for cavity preservation - 80 mm incl. support for round jet tip (Tip RST-xx separately available)	44,-	

Adapter diffusor

4	MA-32-1/4-7/8	7/8" (F) x 1/4" NPS (M) - Edelstahl / Stainless steel	24,-	
---	---------------	---	------	--

Rundstrahldüse Elektrostatik / Round jet tip electrostatic

5	MA-RST-E-Rxx	Rundstrahldüse für Elektrostatik inkl. Aufnahme - 11/15/16 Round jet tip for Electrostatic incl. support - 11/15/16	70,-	
---	--------------	--	------	--



OPTION PRIVATE LABEL

Erhalten Sie MASPRA Wendedüsen individuell und **nach Ihren Wünschen gefertigt**.

Bestimmen Sie das **Design**, die **Farbe** und das **Branding** Ihrer eigenen Düse.

*Get your customized MASPRA reversible tips according to **your individual requirements**.*

Define the design, the color and the branding of your own tip.



Das **UNIVERSAL** Wendedüsen-**system** aus Deutschland.

Mit der MASPRA UNIVERSAL produzieren wir ein **universelles Düsensystem**.

Dieses ist in verschiedenen Ausführungen erhältlich und **austauschbar mit den bekannten Marken**.

UNIVERSAL reversible tip from Germany.

With the MASPRA UNIVERSAL we produce an **universal tip system**.

This is available in different versions and is **interchangeable with the well-known brands**.

TRITECH • WAGNER (TradeTip)
AIRLESSCO (ARV) • ASM (UniTIP)
GRACO (RacV) • TITAN (SC-6)



MADE IN  **GERMANY**



MASTER QUALITY REVERSIBLE TIPS

HIGH PRESSURE AIRLESS REVERSIBLE SPRAY TIPS



MASPRA SPRAY PARAMETER

Entspricht in Durchflussmenge und Spritzstrahlwinkel dem Durchschnitt der bekannten Herstellermodelle.

Matches the flow rate and spray angle parameters of the average of well-known manufacturer models.



Art.-Nr. / Part-No.
MT-U-xxx
Standard

MASPRA Universal
Standard - max. 280 bar

26,- € Listenpreis
List price

Art.-Nr. / Part-No.
MT-U-xxx-FF
FineFinish

MASPRA Universal
FineFinish - max. 280 bar

Mit Vorzerstäuber
With preorifice

30,- € Listenpreis
List price

Art.-Nr. / Part-No.
MT-U-xxx-HD
Heavy Duty

MASPRA Universal
Heavy Duty - max. 500 bar

Hochdruck
High pressure

30,- € Listenpreis
List price

Art.-Nr. / Part-No.
MT-U-xxx-ST
Striping

MASPRA Universal
Striping - max. 280 bar

Markierdüse
Line marking

30,- € Listenpreis
List price

Art.-Nr. / Part-No.
MT-U-xxx-LP
Low Pressure

MASPRA Universal
Low Pressure - max. 280 bar

Niederdruck
Low pressure

30,- € Listenpreis
List price

OPTION
PRIVATE LABEL

MADE IN GERMANY

Von 0-500 bar - Jede Größe produzierbar
From 0-500 bar - Each size can be produced

MASPRA
MASTER SPRAY

GRACO
SPRAY PARAMETER

Entspricht in Durchflussmenge und Spritzstrahlwinkel den Parametern der Graco RacV Wendedüsen.

Matches the flow rate and spray angle parameters of Graco RacV reversible tips.



Art.-Nr. / Part-No.
MT-U-GR-xxx
Standard

MASPRA GR-Version
Standard - max. 280 bar

28,- € Listenpreis
List price

WAGNER
SPRAY PARAMETER

Entspricht in Durchflussmenge und Spritzstrahlwinkel den Parametern der Wagner TradeTip Wendedüsen.

Matches the flow rate and spray angle parameters of Wagner TradeTip reversible tips.



Art.-Nr. / Part-No.
MT-U-W-xxx
Standard

MASPRA W-Version
Standard - max. 280 bar

28,- € Listenpreis
List price

<p>Art.-Nr. / Part-No. MT-U-GR-xxx-FF FineFinish</p> <p>MASPRA GR-Version FineFinish - max. 280 bar</p> <p>Mit Vorzerstäuber <i>With preorifice</i></p> <p>32,- € <small>Listenpreis List price</small></p>	<p>Art.-Nr. / Part-No. MT-U-GR-xxx-HD Heavy Duty</p> <p>MASPRA GR-Version Heavy Duty - max. 500 bar</p> <p>Hochdruck <i>High pressure</i></p> <p>32,- € <small>Listenpreis List price</small></p>	<p>Art.-Nr. / Part-No. MT-U-GR-xxx-ST Striping</p> <p>MASPRA GR-Version Striping - max. 280 bar</p> <p>Markierdüse <i>Line marking</i></p> <p>32,- € <small>Listenpreis List price</small></p>	<p>Art.-Nr. / Part-No. MT-U-GR-xxx-LP Low Pressure</p> <p>MASPRA GR-Version Low Pressure - max. 280 bar</p> <p>Niederdruck <i>Low pressure</i></p> <p>32,- € <small>Listenpreis List price</small></p>
--	--	---	---

<p>Art.-Nr. / Part-No. MT-U-W-xxx-FF FineFinish</p> <p>MASPRA W-Version FineFinish - max. 280 bar</p> <p>Mit Vorzerstäuber <i>With preorifice</i></p> <p>32,- € <small>Listenpreis List price</small></p>	<p>Art.-Nr. / Part-No. MT-U-W-xxx-HD Heavy Duty</p> <p>MASPRA W-Version Heavy Duty - max. 500 bar</p> <p>Hochdruck <i>High pressure</i></p> <p>32,- € <small>Listenpreis List price</small></p>	<p>Art.-Nr. / Part-No. MT-U-W-xxx-ST Striping</p> <p>MASPRA W-Version Striping - max. 280 bar</p> <p>Markierdüse <i>Line marking</i></p> <p>32,- € <small>Listenpreis List price</small></p>	<p>Art.-Nr. / Part-No. MT-U-W-xxx-LP Low Pressure</p> <p>MASPRA W-Version Low Pressure - max. 280 bar</p> <p>Niederdruck <i>Low pressure</i></p> <p>32,- € <small>Listenpreis List price</small></p>
--	--	---	---

OPTION PRIVATE LABEL **MADE IN GERMANY** Von 0-500 bar - Jede Größe produzierbar
From 0-500 bar - Each size can be produced

OPTION PRIVATE LABEL **MADE IN GERMANY** Von 0-500 bar - Jede Größe produzierbar
From 0-500 bar - Each size can be produced

TITAN
SPRAY PARAMETER

Entspricht in Durchflussmenge und Spritzstrahlwinkel den Parametern der Titan SC-6 Wendedüsen.

Matches the flow rate and spray angle parameters of Titan SC-6 reversible tips.



Art.-Nr. / Part-No.
MT-U-TI-xxx
Standard

MASPRA TI-Version
Standard - max. 280 bar

28,- € Listenpreis
List price

<p>Art.-Nr. / Part-No. MT-U-TI-xxx-FF FineFinish</p> <p>MASPRA TI-Version FineFinish - max. 280 bar</p> <p>Mit Vorzerstäuber <i>With preorifice</i></p> <p>32,- € <small>Listenpreis List price</small></p>	<p>Art.-Nr. / Part-No. MT-U-TI-xxx-HD Heavy Duty</p> <p>MASPRA TI-Version Heavy Duty - max. 500 bar</p> <p>Hochdruck <i>High pressure</i></p> <p>32,- € <small>Listenpreis List price</small></p>	<p>Art.-Nr. / Part-No. MT-U-TI-xxx-ST Striping</p> <p>MASPRA TI-Version Striping - max. 280 bar</p> <p>Markierdüse <i>Line marking</i></p> <p>32,- € <small>Listenpreis List price</small></p>	<p>Art.-Nr. / Part-No. MT-U-TI-xxx-LP Low Pressure</p> <p>MASPRA TI-Version Low Pressure - max. 280 bar</p> <p>Niederdruck <i>Low pressure</i></p> <p>32,- € <small>Listenpreis List price</small></p>
---	---	--	--

Art.-Nr. / Part-No.
MT-U-BASE-F
11/16"

MT-U-BASE-G
7/8"

MASPRA Universal
Düsenhalter
• 11/16" oder 7/8"
• Max. 500 bar

MASPRA Universal
tip base
• 11/16" or 7/8"
• Max. 500 bar

18,- € Listenpreis
List price



Art.-Nr. / Part-No.
MT-U-SEAL-5

MASPRA Universal
Dichtungssatz (5 Stück)
Seal kit (5 pieces)

18,- € Listenpreis
List price



OPTION PRIVATE LABEL **MADE IN GERMANY** Von 0-500 bar - Jede Größe produzierbar
From 0-500 bar - Each size can be produced



AirCombi Düsen aus Deutschland.

MASPRA AirCombi Düsen sind die **hochwertige, zuverlässige** und **preiswerte Alternative**.

Alle Düsen sind **kompatibel** mit den Luftkappen aus eigener Produktion oder der Original-Hersteller.

Diese sind in verschiedenen Ausführungen erhältlich und **austauschbar mit den bekannten Marken**.

AirCombi tips from Germany.

MASPRA AirCombi tips are the **high-quality, reliable** and **economic alternative**.

All tips are **compatible** with our own AirCaps or with those of original manufacturers.

These are available in different versions and is **interchangeable with the well-known brands**.

MASPRA	kompatibel mit <i>compatible with</i>
Type "O-R"	Optima 2000
Type "O-H"	Optima 2100
Type "GR"	Graco AAM/AAF/AXM/AXF
Type "KR"	Kremlin
Type "W"	Wagner 379xxx
Type "S"	Sagola



 **OPTION**
PRIVATE LABEL

MADE IN  GERMANY



MASTER QUALITY
AIRCOMBI TIPS

HIGH PRESSURE AIRCOMBI SPRAY TIPS

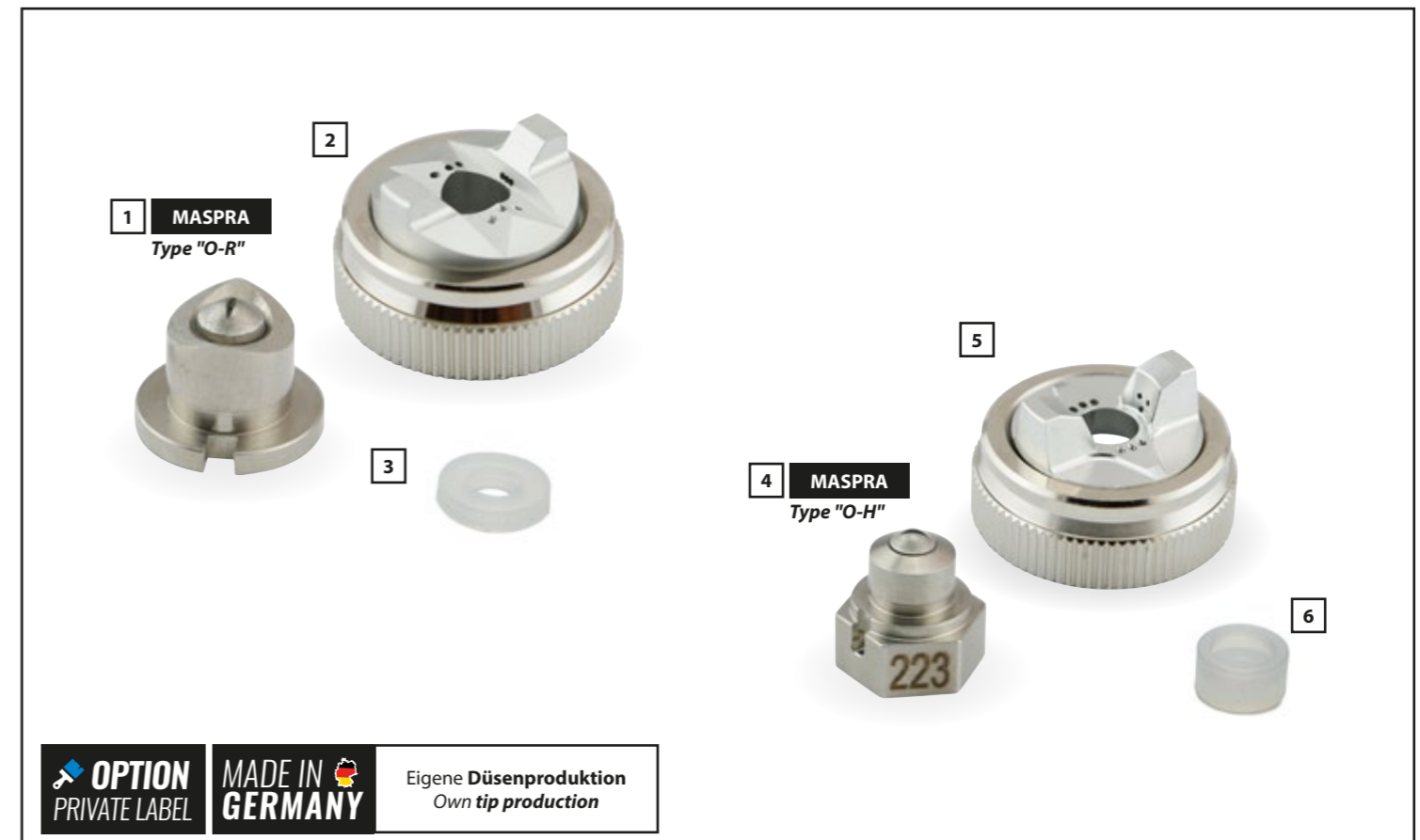

OPTION PRIVATE LABEL **MADE IN GERMANY** Eigene Düsenproduktion
Own tip production

AirCombi				
Pos.	Art.-Nr. Part-No.	Artikelbeschreibung Description	Listenpreis List price €/Stück €/piece	Netto-Stückpreis bei Net unit price for
Type "O-R" - OPTIMA 2000				
1	MA-AC-O-xxx-LB	Düse runde Ausführung Tip round version	32,-	
2	MA-AC-O-R-LB	Luftkappe runde Ausführung AirCap round version	78,-	
3	MA-AC-O-SEAL-LB	Düsendichtung runde Ausführung (10x) Tip seal round version (10x)	4,-	
Type "O-H" - OPTIMA 2100				
4	MA-AC-O-H-xxx-LB	Düse sechskant Ausführung Tip hexagon version	42,-	
5	MA-AC-O-H-LB	Luftkappe sechskant Ausführung AirCap hexagon version	78,-	
6	MA-AC-O-H-SEAL-LB	Düsendichtung sechskant Ausführung (1x) Tip seal hexagon version (1x)	4,20	

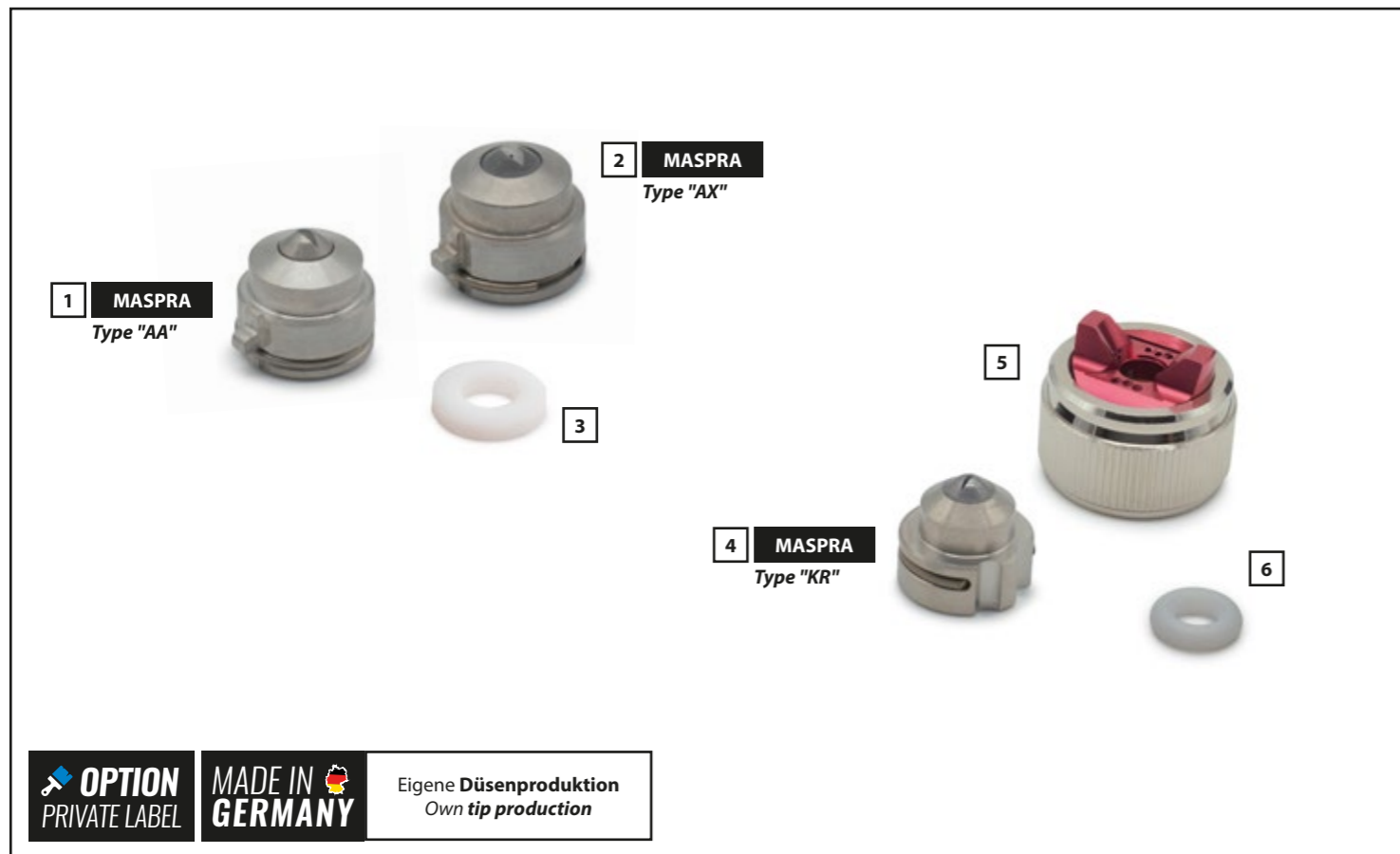

AirCombi

Pos.	Art.-Nr. Part-No.	Artikelbeschreibung Description	Listenpreis List price €/Stück €/piece	Netto-Stückpreis bei Net unit price for
------	----------------------	------------------------------------	---	--

Type "GR" - GRACO AAM/AAF/AXM/AXF

1	MA-AC-GR-AA-xxx-LB	Düse Typ "AA" Tip type "AA"	42,-	
	MA-AC-GR-AF-xxx-LB	Düse Typ "AF" - Mit Vorzerstäuber Tip type "AF" - With preorifice	46,-	
2	MA-AC-GR-AX-xxx-LB	Düse Typ "AX" Tip type "AX"	42,-	
	MA-AC-GR-AXF-xxx-LB	Düse Typ "AXF" - Mit Vorzerstäuber Tip type "AXF" - With preorifice	46,-	
3	MA-AC-GR-SEAL-LB	Düsendichtung "GR" Ausführung (10x) Tip seal "GR" version (10x)	4,-	

Type "KR" - KREMLIN

4	MA-AC-65-xxxx4-LB	Düse standard Ausführung Tip standard version	36,-	
	MA-AC-65-xxxx2-LB	Düse mit Vorzerstäuber Tip with preorifice	42,-	
5	MA-AC-6524-LB	Luftkappe Typ "24" AirCap type "24"	78,-	
6	MA-AC-65-SEAL-LB	Düsendichtung "KR" Ausführung (10x) Tip seal "KR" version (10x)	20,-	



AirCombi

Pos.	Art.-Nr. Part-No.	Artikelbeschreibung Description	Listenpreis List price €/Stück €/piece	Netto-Stückpreis bei Net unit price for
------	----------------------	------------------------------------	---	--

Type "W" - WAGNER 379

1	MA-AC-W4-xxx-LB	Düse standard Ausführung - Edelstahl Tip standard version - stainless steel	36,-	
2	MA-AC-W47-R-LB	Luftkappe rote Ausführung AirCap red version	78,-	
	MA-AC-W47-B-LB	Luftkappe blaue Ausführung AirCap blue version		
3	MA-AC-W4-SEAL-LB	Düsendichtung "W4" Ausführung (1x) - Ref. W394338-LB Tip seal "W4" version (1x) - Ref. W394338-LB	5,40	
4	W394339-LB	Dichtring "W4" Ausführung Diffusor seal "W4" version	8,20	

Type "S" - SAGOLA

5	MA-AC-S-xxx-LB	Düse standard Ausführung Tip standard version	42,-	
	MA-AC-SF-xxx-LB	Düse mit Vorzerstäuber Tip with preorifice	46,-	
6	MA-AC-S-SEAL-LB	Düsendichtung "S" Ausführung (10x) Tip seal "S" version (10x)	4,-	

GUN, PUMP & SUCTION FILTER SYSTEMS

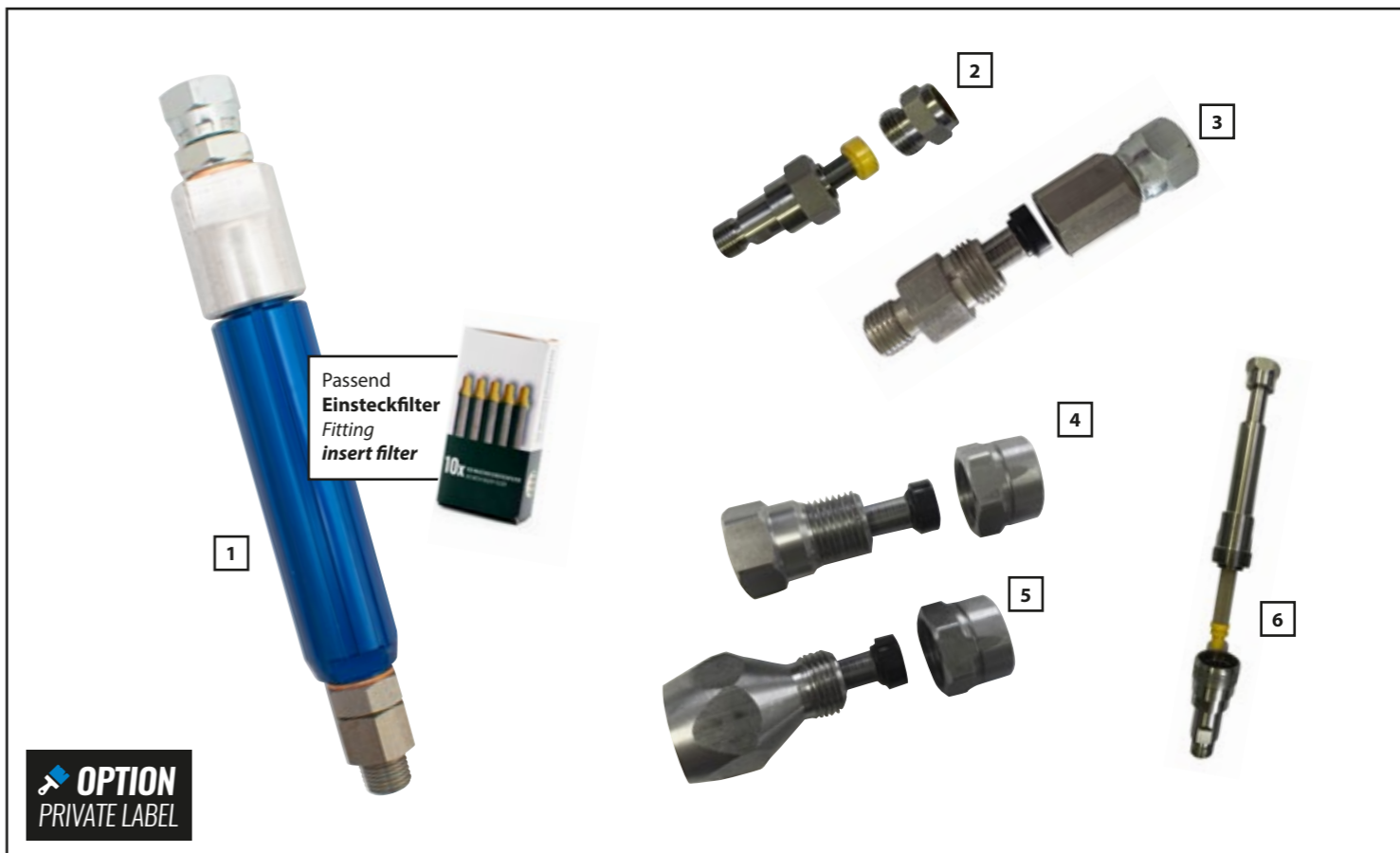

OPTION
PRIVATE LABEL

Filter-Gehäuse / Filter housing

Pos.	Art.-Nr. Part-No.	Artikelbeschreibung Description	Listenpreis List price €/Stück €/piece	Netto-Stückpreis bei Net unit price for
------	----------------------	------------------------------------	---	--

Einsteckfilter Lang / Insert filter long

1	HOSE-FI-1/4-B	Schlauch-Filtergehäuse kompl. / Hose-filter housing cpl. - 1/4" BSP adapter alu	72,-	
	HOSE-FI-1/4-B-SS	Schlauch-Filtergehäuse kompl. / Hose-filter housing cpl. - 1/4" BSP adapter SS	84,-	

SPALT filter

2	63004-BSP	Edelstahl / Stainless steel - Mini - 1/4" AG (M) - 1/4" IG (F) - BSP	36,-	
3	107300	Edelstahl / Stainless steel - 1/4" IG (F) - 1/4" AG (M) - NPS	44,-	
4	63006	Diffuser Filtergehäuse Edelstahl / Diffusor filter housing stainless steel - 11/16"	28,-	
5	63007	Diffuser Filtergehäuse Edelstahl / Diffusor filter housing stainless steel - 7/8"		

Einsteckfilter Lang / Insert filter long

6	63001	Edelstahl / Stainless steel - 1/4" IG (F) - 1/4" AG (M) - BSP	58,-	
---	-------	---	------	--

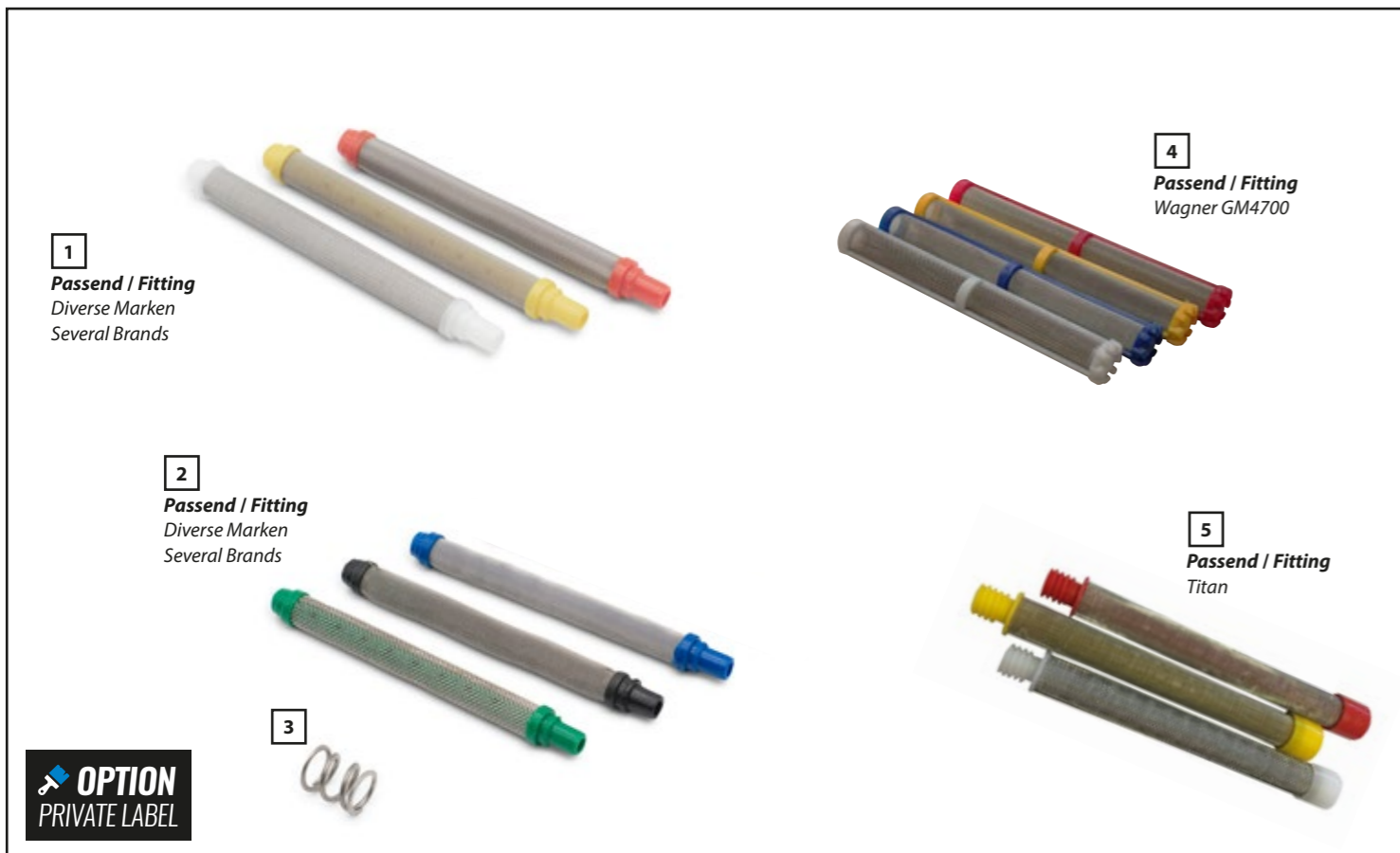

1
Passend / Fitting
Diverse Marken
Several Brands

4
Passend / Fitting
Wagner GM4700

2
Passend / Fitting
Diverse Marken
Several Brands

5
Passend / Fitting
Titan

3

OPTION
PRIVATE LABEL

Pistolenfilter / Gun filter

Pos.	Art.-Nr. Part-No.	Artikelbeschreibung Description	Listenpreis List price	Netto-Stückpreis bei Net unit price for
			€/Stück €/piece	

Einsteckfilter / Insert filter

1	HS34377-NEW	weiss - 50 Maschen / white - 50 mesh	Mindestabnahme: 10 Stk. = Verpackungseinheit Minimum order quantity: 10 pcs. = packaging unit	1,40	
	HS43235-NEW	gelb - 100 Maschen / yellow - 100 mesh			
	HS34383-NEW	rot - 200 Maschen / red - 200 mesh			

2	HS89323-LB	grün - 30 Maschen / green - 30 mesh	Mindestabnahme: 10 Stk. = Verpackungseinheit Minimum order quantity: 10 pcs. = packaging unit	1,40	
	HS34379-LB	schwarz - 70 Maschen / black - 70 mesh			
	HS34382-LB	blau - 150 Maschen / blue - 150 mesh			

3	77113	Feder / Spring	2,40		
---	-------	----------------	------	--	--

4	W231-50-LB	weiss - 50 Maschen / white - 50 mesh	Mindestabnahme: 10 Stk. = Verpackungseinheit Minimum order quantity: 10 pcs. = packaging unit	1,80	
	W231-100-LB	gelb - 100 Maschen / yellow - 100 mesh			
	W231-150-LB	blau - 150 Maschen / blue - 150 mesh			
	W231-200-LB	rot - 200 Maschen / red - 200 mesh			

Einschraubfilter / Screw-in filter

5	TIFI-60-LB	weiss - 60 Maschen / white - 60 mesh	Mindestabnahme: 10 Stk. = Verpackungseinheit Minimum order quantity: 10 pcs. = packaging unit	1,80	
	TIFI-100-LB	gelb - 100 Maschen / yellow - 100 mesh			
	TIFI-150-LB	rot - 150 Maschen / red - 150 mesh			



1
Passend / Fitting
Graco

3
Passend / Fitting
Graco, Wagner, etc.

2
Passend / Fitting
Graco

4
Passend / Fitting
Optima

OPTION
PRIVATE LABEL

Pistolenfilter / Gun filter

Pos.	Art.-Nr. Part-No.	Artikelbeschreibung Description	Listenpreis List price	Netto-Stückpreis bei Net unit price for
			€/Stück €/piece	

1	GR218-50-LB	blau - 50 Maschen / blue - 50 mesh	Mindestabnahme: 10 Stk. = Verpackungseinheit Minimum order quantity: 10 pcs. = packaging unit	2,20	
	GR218-100-LB	orange - 100 Maschen / orange - 100 mesh			

2	GR287-60-LB	schwarz - 60 Maschen / black - 60 mesh	Mindestabnahme: 10 Stk. = Verpackungseinheit Minimum order quantity: 10 pcs. = packaging unit	2,40	
	GR287-100-LB	blau - 100 Maschen / blue - 100 mesh			
	GR287-150-LB	orange - 150 Maschen / orange - 150 mesh			

SPALT Filter Edelstahl / Stainless steel

3	SPALT60-LB	weiss - 60 Maschen / white - 60 mesh	Mindestabnahme: 10 Stk. = Verpackungseinheit Minimum order quantity: 10 pcs. = packaging unit	6,80	
	SPALT80-LB	blau - 80 Maschen / blue - 80 mesh			
	SPALT100-LB	schwarz - 100 Maschen / black - 100 mesh		9,-	
	SPALT200-LB	gelb - 200 Maschen / yellow - 200 mesh			

Einschraubfilter / Screw-in filter

4	HS82008-LB	weiß - 80 Maschen / white - 80 mesh	Mindestabnahme: 10 Stk. = Verpackungseinheit Minimum order quantity: 10 pcs. = packaging unit	1,40	
	HS82016-LB	gelb - 150 Maschen / yellow - 150 mesh			
	HS82030-LB	rot - 295 Maschen / red - 295 mesh			

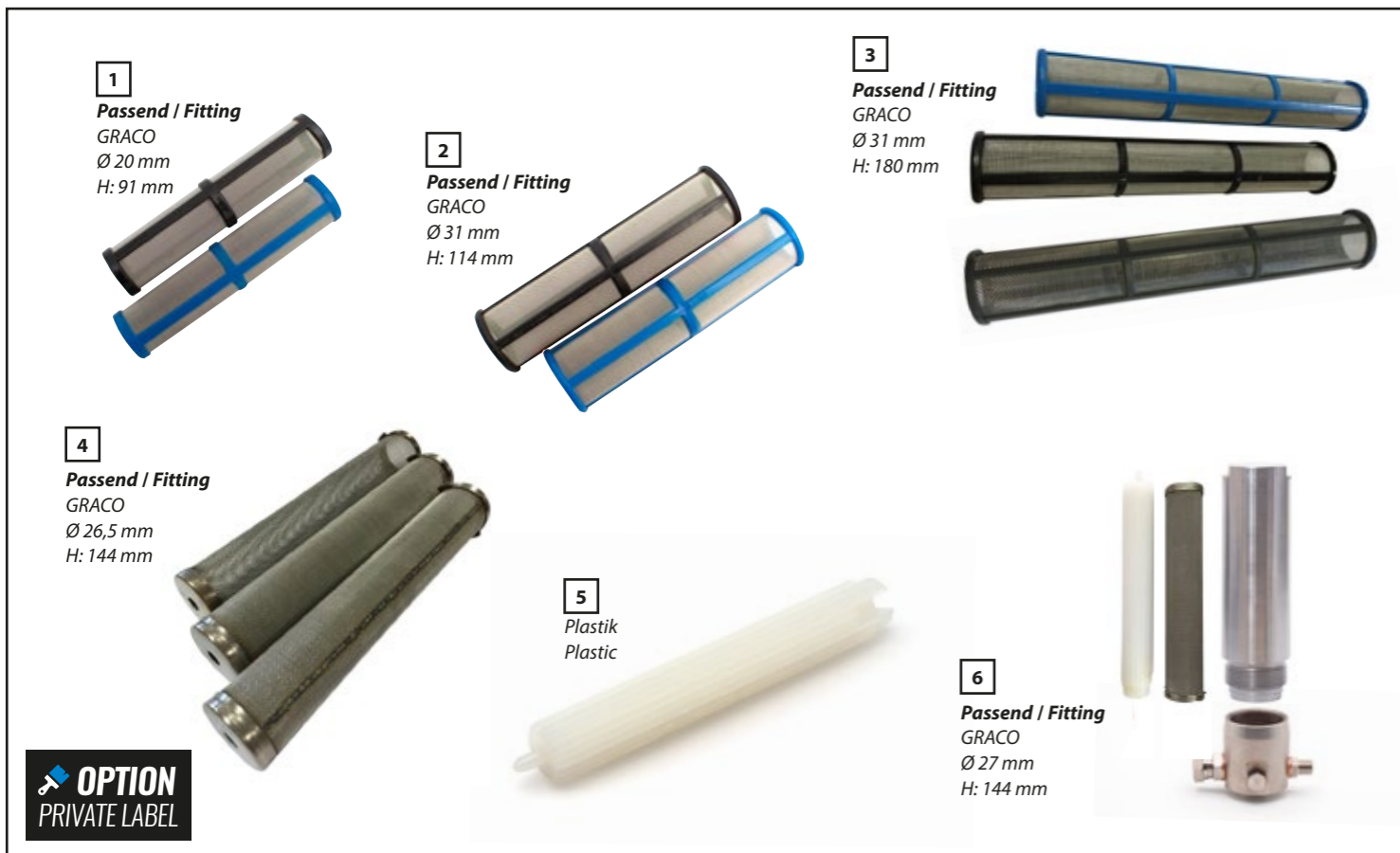

Hochdruckfilter / High pressure filter typ "GR"

Pos.	Art.-Nr. Part-No.	Artikelbeschreibung Description	Listenpreis List price €/Stück €/piece	Netto-Stückpreis bei Net unit price for
1	GR246-60-LB	kurz - schwarz - 60 Maschen / short - black - 60 mesh	3,60	
	GR246-100-LB	kurz - blau - 100 Maschen / short - blue - 100 mesh		
2	GR243-60-LB	mittel - schwarz - 60 Maschen / medium - black - 60 mesh	4,60	
	GR243-100-LB	mittel - blau - 100 Maschen / medium - blue - 100 mesh		
3	GR244-30-LB	lang - grau - 30 Maschen / long - grey - 30 mesh	6,40	
	GR244-60-LB	lang - schwarz - 60 Maschen / long - black - 60 mesh		
	GR244-100-LB	lang - blau - 100 Maschen / long - blue - 100 mesh		
4	HDFG-15-LB	15 Maschen / 15 mesh - 144 mm	3,40	
	HDFG-30-LB	30 Maschen / 30 mesh - 144 mm		
	HDFG-60-LB	60 Maschen / 60 mesh - 144 mm		
	HDFG-80-LB	80 Maschen / 80 mesh - 144 mm	3,60	
	HDFG-100-LB	100 Maschen / 100 mesh - 144 mm		
	HDFG-150-LB	150 Maschen / 150 mesh - 144 mm		
	HDFG-200-LB	200 Maschen / 200 mesh - 144 mm	4,-	
5	3000-K	Filterstütze Plastik / Filter support plastic	6,60	

Hochdruckfilter-Gehäuse / High pressure filter housing

Pos.	Art.-Nr. Part-No.	Artikelbeschreibung Description	Listenpreis List price €/Stück €/piece	Netto-Stückpreis bei Net unit price for
6	HP-FI-LO-N	3/8" NPS (F) - 1/4" NPS (M) Edelstahl ohne Filter und Stütze / Stainless steel without filter and support	198,-	



Hochdruckfilter / High pressure filter typ "W"

Pos.	Art.-Nr. Part-No.	Artikelbeschreibung Description	Listenpreis List price €/Stück €/piece	Netto-Stückpreis bei Net unit price for
1	W351-20-LB	20 Maschen / 20 mesh - 144 mm	10,40	
	W351-50-LB	50 Maschen / 50 mesh - 144 mm		
	W351-100-LB	100 Maschen / 100 mesh - 144 mm		
	W351-200-LB	200 Maschen / 200 mesh - 144 mm		
2	W989-LB	Filterstütze / Filter support	13,20	
3	W508-30-LB	30 Maschen / 30 mesh - ProSpray	7,80	
	W508-60-LB	60 Maschen / 60 mesh - ProSpray		
	W508-100-LB	100 Maschen / 100 mesh - ProSpray		
4	T500-60-LB	Schwarz - 60 Maschen / black - 60 mesh	11,-	
	T500-100-LB	Weiß - 100 Maschen / white - 100 mesh		
5	W349-50-LB	50 Maschen / 50 mesh	28,-	

Hochdruckfilter-Gehäuse / High pressure filter housing

Pos.	Art.-Nr. Part-No.	Artikelbeschreibung Description	Listenpreis List price €/Stück €/piece	Netto-Stückpreis bei Net unit price for
6	HP-FI-LO-N	3/8" NPS (F) - 1/4" NPS (M) Edelstahl ohne Filter und Stütze / Stainless steel without filter and support	198,-	
	HP-FI-LO-M	3/8" NPS (F) - M16x1.5 (M) Edelstahl ohne Filter und Stütze / Stainless steel without filter and support		

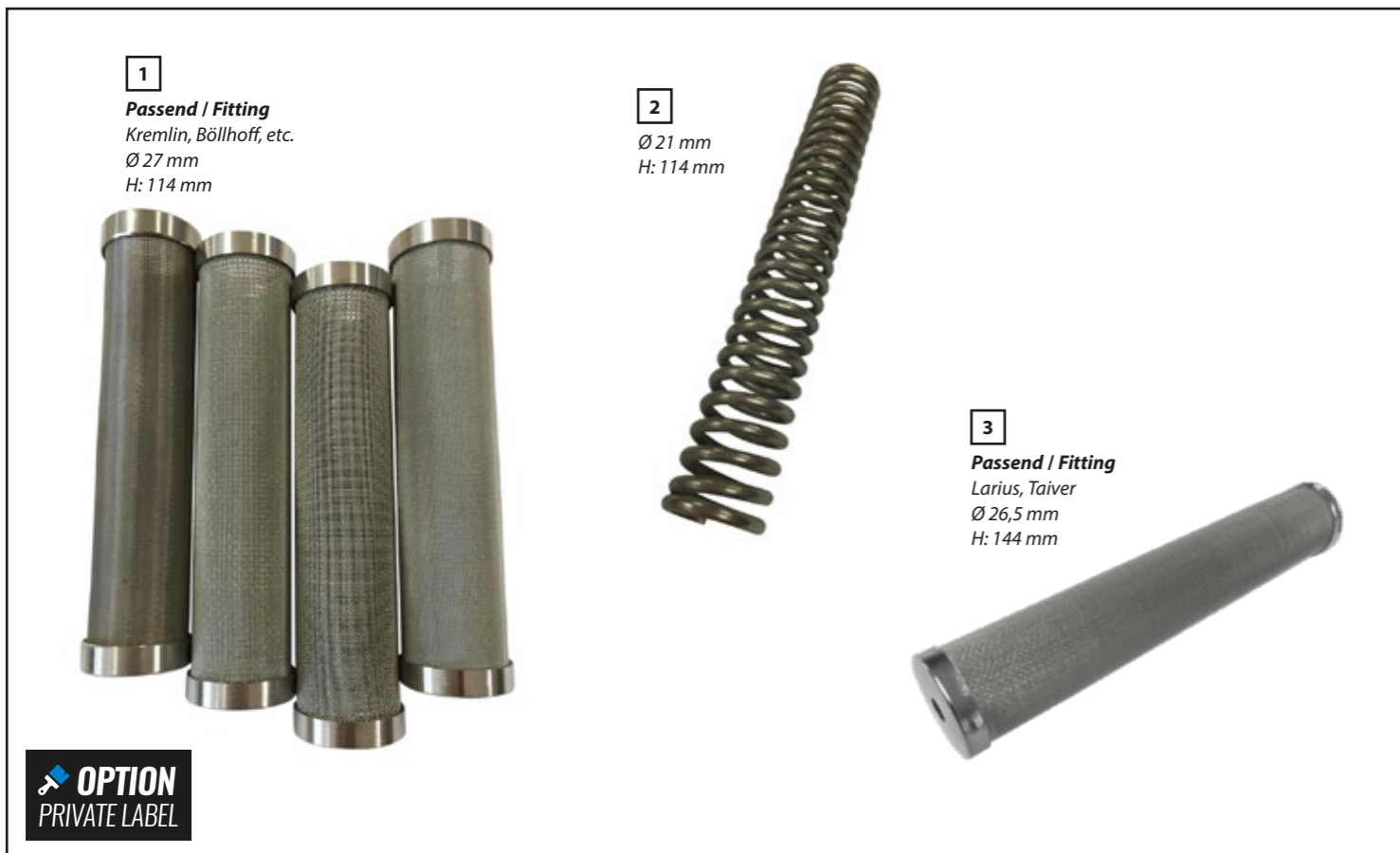

1
Passend / Fitting
 Kremlin, Böllhoff, etc.
 Ø 27 mm
 H: 114 mm

2
 Ø 21 mm
 H: 114 mm

3
Passend / Fitting
 Larius, Taiver
 Ø 26,5 mm
 H: 144 mm

OPTION
 PRIVATE LABEL

Hochdruckfilter / High pressure filter

Pos.	Art.-Nr. Part-No.	Artikelbeschreibung Description	Listenpreis List price	Netto-Stückpreis bei Net unit price for
1	HDF02-LB	Nr. 2 - 200 Maschen / No. 2 - 200 mesh	7,40	
	HDF03-LB	Nr. 3 - 180 Maschen / No. 3 - 180 mesh		
	HDF04-LB	Nr. 4 - 165 Maschen / No. 4 - 165 mesh		
	HDF05-LB	Nr. 5 - 100 Maschen / No. 5 - 100 mesh		
	HDF06-LB	Nr. 6 - 80 Maschen / No. 6 - 80 mesh		
	HDF09-LB	Nr. 9 - 60 Maschen / No. 9 - 60 mesh		
	HDF12-LB	Nr. 12 - 50 Maschen / No. 12 - 50 mesh		
	HDF15-LB	Nr. 15 - 30 Maschen / No. 15 - 30 mesh		
2	FIU-S-LB	Filterstütze / Filter support	11,60	
3	HDF-L/T-30	Ohne Flügel - 30 Maschen / Without wings - 30 mesh	2,80	
	HDF-L/T-60	Ohne Flügel - 60 Maschen / Without wings - 60 mesh		
	HDF-L/T-100	Ohne Flügel - 100 Maschen / Without wings - 100 mesh		
	HDF-L/T-200	Ohne Flügel - 200 Maschen / Without wings - 200 mesh		



1
Passend / Fitting
 WIWA
 Ø 26 mm
 H: 53 mm

2a
Passend / Fitting
 WIWA
 Ø 33,5 mm
 H: 130 mm

2b
Passend / Fitting
 WIWA
 Ø 36,4 mm
 H: 121 mm

3
Passend / Fitting
 Binks, WIWA
 Ø 32 mm
 H: 61,5 mm

4
Passend / Fitting
 Binks, WIWA
 Ø 32 mm
 H: 99,5 mm

OPTION
 PRIVATE LABEL

Hochdruckfilter / High pressure filter

Pos.	Art.-Nr. Part-No.	Artikelbeschreibung Description	Listenpreis List price	Netto-Stückpreis bei Net unit price for
1	HDW-50-LB	orange - 50 Maschen / orange - 50 mesh	4,40	
	HDW-70-LB	gelb - 70 Maschen / yellow - 70 mesh		
	HDW-100-LB	schwarz - 100 Maschen / black - 100 mesh		
	HDW-150-LB	rot - 150 Maschen / red - 150 mesh		
	HDW-200-LB	weiss - 200 Maschen / white - 200 mesh		
2a	HDW162-30-LB	blau - 30 Maschen / blue - 30 mesh	6,-	
	HDW162-50-LB	orange - 50 Maschen / orange - 50 mesh		
	HDW162-70-LB	gelb - 70 Maschen / yellow - 70 mesh		
	HDW162-100-LB	schwarz - 100 Maschen / black - 100 mesh		
	HDW162-150-LB	rot - 150 Maschen / red - 150 mesh		
2b	HDW659-30-LB	blau - 30 Maschen / blue - 30 mesh	7,20	
	HDW659-50-LB	orange - 50 Maschen / orange - 50 mesh		
	HDW659-70-LB	gelb - 70 Maschen / yellow - 70 mesh		
	HDW659-100-LB	schwarz - 100 Maschen / black - 100 mesh		
	HDW659-150-LB	rot - 150 Maschen / red - 150 mesh		
3	HDH-II-50-LB	50 Maschen - Edelstahl / 50 mesh - stainless steel - TYP II	26,-	
	HDH-II-100-LB	100 Maschen - Edelstahl / 100 mesh - stainless steel - TYP II		
4	HDH-III-50-LB	50 Maschen - Edelstahl / 50 mesh - stainless steel - TYP III	30,-	
	HDH-III-100-LB	100 Maschen - Edelstahl / 100 mesh - stainless steel - TYP III		



Ansaugfilter / Suction filter

Pos.	Art.-Nr. Part-No.	Artikelbeschreibung Description	Listenpreis List price	Netto-Stückpreis bei Net unit price for
			€/Stück €/piece	
1	AF-H-15-xxx	15 Maschen / 15 Mesh - 1/2" / 3/4" / 1" / M28 / M38 - Hexagon	24,-	
	AF-H-30-xxx	30 Maschen / 30 Mesh - M28 - Hexagon		
2	ANF-R-15-xxx	15 Maschen / 15 Mesh - 1/2" / 3/4" / 7/8" / 1" / M15 / M28 - Round	12,-	
	ANF-R-15-3/4-UNF	15 Maschen / 15 Mesh - 3/4" UNF - Round (GR235004)		
	ANF-R-30-xxx	30 Maschen / 30 Mesh - 1/2" / 3/4" / 1" / M15 / M28 - Round		
	ANF-R-60-xxx	60 Maschen / 60 Mesh - 1/2" / M15 - Round		
3	ANF-MINI-1/2	30 Maschen / 30 Mesh - 1/2"	12,-	
	ANF-MINI-M15	30 Maschen / 30 Mesh - M15		
4	2011101	grob/rough - Ø 28	25,-	
	2011102	fein/smooth - Ø 28		
	2011103	grob/rough - Ø 22		
	2011104	fein/smooth - Ø 22		
5	AF-GR-7/8-LB	7/8" - ST MAX 395/495 (GR246385)	5,40	
	AF-GR-1-LB	1" - MARK/MAX (GR189920)		
6	W97531-LB	Filterbeutel / Filter bag - ca. 300 µ	10,40	

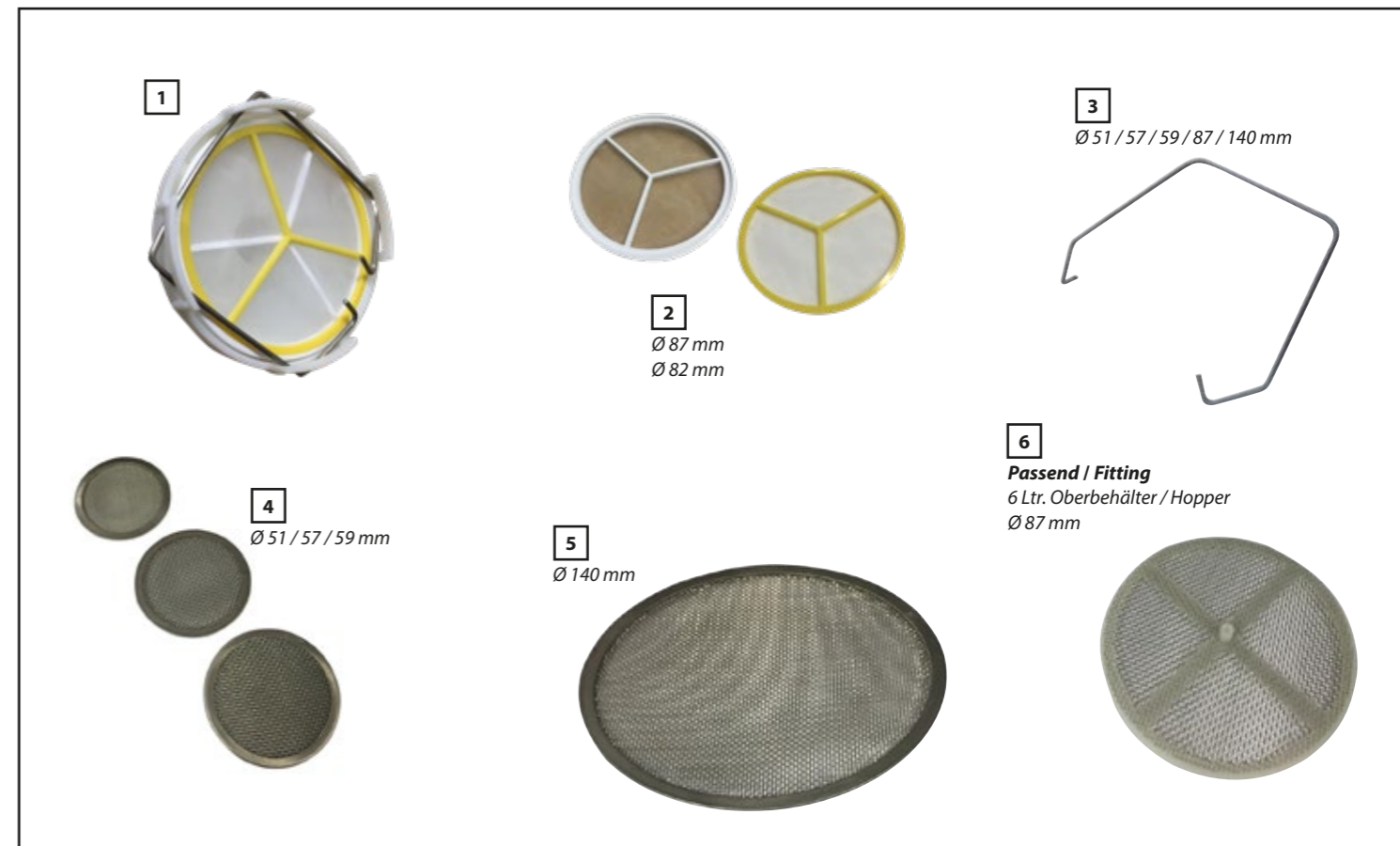

Filterglocken & -scheiben / Suction housings & filter discs

Pos.	Art.-Nr. Part-No.	Artikelbeschreibung Description	Listenpreis List price	Netto-Stückpreis bei Net unit price for
			€/Stück €/piece	
1	FG-KPL-M15-LB	Filterglocke kpl. / Filter housing cpl. - M15x1	10,-	
	FG-KPL-1/2-LB	Filterglocke kpl. / Filter housing cpl. - 1/2"		
2	FD-87-50-LB	Filterscheibe weiß / Filter disc white - D87 - 50 mesh	1,80	
	FD-82-100-LB	Filterscheibe gelb / Filter disc yellow - D82 - 100 mesh		
3	SR87-LB	Sprengring Edelstahl / Snap ring stainless steel	6,20	
4	FD-51-xx-LB	Filterscheibe - 20/40 Maschen - D51 Filter disc - 20/40 mesh - D51	3,-	
	FD-57-xx-LB	Filterscheibe - 20/40 Maschen - D57 Filter disc - 20/40 mesh - D57		
	FD-59-xx-LB	Filterscheibe Edelstahl 20/50 Maschen - D59 Filter disc stainless steel 20/50 mesh - D59		
5	FD-140-xx-LB	Filterscheibe Edelstahl - 20/50/70 Maschen - D140 Filter disc stainless steel - 20/50/70 mesh - D140	9,20	
3	SR-xx-LB	Sprengring Edelstahl / Snap ring stainless steel - D51/57/59	6,-	
	SR140-LB	Sprengring Edelstahl / Snap ring stainless steel - D140	11,60	
6	FI-HÜ	Filterscheibe 20 Maschen / Filter disc 20 mesh - D87 (6 ltr.)	2,80	



1
Passend / Fitting
Kremlin

2
Passend / Fitting
Kremlin

Pos.	Art.-Nr. Part-No.	Artikelbeschreibung Description	Listenpreis List price	Netto-Stückpreis bei Net unit price for
			€/Stück €/piece	
Düsenfilter / Tip filter				
1	KR-TIP-75-LB	Micro-Filter 75 Maschen (10x) Micro filter 75 mesh (10x)	10,-	
	KR-TIP-100-LB	Micro-Filter 100 Maschen (10x) Micro filter 100 mesh (10x)		
	KR-TIP-140-LB	Micro-Filter 140 Maschen (10x) Micro filter 140 mesh (10x)		
Pistolenfilter / Gun filter				
2	KR-4-85-LB	Ersatzfilter lang Nr. 6 - 85 Maschen (5x) Replacement filter long No. 6 - 85 mesh (5x)	2,-	
	KR-4-100-LB	Ersatzfilter lang - 100 Maschen (5x) Replacement filter long - 100 mesh (5x)		
	KR-4-140-LB	Ersatzfilter lang Nr. 4 - 140 Maschen (5x) Replacement filter long No. 4 - 140 mesh (5x)		



1
Filtergehäuse
Filter housing
1/4"
3/8"

2

3
Passend / Fitting
Fließbecher
Gravity cup

Pos.	Art.-Nr. Part-No.	Artikelbeschreibung Description	Listenpreis List price	Netto-Stückpreis bei Net unit price for
			€/Stück €/piece	
Niederdruck- und Becherfilter / Low pressure and cup filter				
1	NDF-FG-1/4-LB	Delrin - 1/4" NPS (M) x 1/4" NPS (F)	14,-	
	NDF-FG-3/8-LB	Delrin - 3/8" NPS (M) x 3/8" NPS (F)	16,-	
	NDF-FG-3/8-SS-LB	Edelstahl / Stainless steel - 3/8" NPS (M) x 3/8" NPS (F)	20,-	
			€/Stück €/piece	
2	NDF-50-LB	Weiß - 50 Maschen / white - 50 mesh	2,-	
	NDF-110-LB	Blau - 110 Maschen / blue - 110 mesh		
	NDF-180-LB	Rot - 180 Maschen / red - 180 mesh		
	NDF-250-LB	Grün - 250 Maschen / green - 250 mesh		
3	35155-60-NY-LB	60 Maschen - Nylon / 60 mesh - Nylon	1,20	
	35155-60-SS-LB	60 Maschen - Edelstahl / 60 mesh - Stainless steel		
	35155-100-NY-LB	100 Maschen - Nylon / 100 mesh - Nylon		
	35155-100-SS-LB	100 Maschen - Edelstahl / 100 mesh - Stainless steel		

HIGH PRESSURE PAINT SPRAY HOSES



Stahlgeflecht
4x Sicherheitsfaktor
Wire braided
4x safety factor

1x Stahl / 1x Wire

Art.-Nr. Part-No.	Artikelbeschreibung Description	Listenpreis List price	Netto-Stückpreis bei Net unit price for	
		€/Stück €/piece		
W1-3/16-7.5-SS-NP	Ø 3/16" - 7.5 Meter - 1/4" NPS Arbeitsdruck 350 bar - Platzdruck 1.400 bar - Edelstahlanschlüsse Working pressure 350 bar - burst pressure 1.400 bar - stainless steel connections	56,-		
W1-1/4-10-SS-NP	Ø 1/4" - 10 Meter - 1/4" NPS Arbeitsdruck 275 bar - Platzdruck 1.100 bar - Edelstahlanschlüsse Working pressure 275 bar - burst pressure 1.100 bar - stainless steel connections	64,-		
W1-1/4-15-SS-NP	Ø 1/4" - 15 Meter - 1/4" NPS Arbeitsdruck 275 bar - Platzdruck 1.100 bar - Edelstahlanschlüsse Working pressure 275 bar - burst pressure 1.100 bar - stainless steel connections	74,-		

2x Stahl / 2x Wire

H-W2-1/4-10-SS	Ø 1/4" - 10 Meter - 1/4" NPS Arbeitsdruck 450 bar - Platzdruck 1.800 bar - Edelstahlanschlüsse Working pressure 450 bar - burst pressure 1.800 bar - stainless steel connections	144,-		
H-W2-1/4-12-SS	Ø 1/4" - 12 Meter - 1/4" NPS Arbeitsdruck 450 bar - Platzdruck 1.800 bar - Edelstahlanschlüsse Working pressure 450 bar - burst pressure 1.800 bar - stainless steel connections	154,-		
H-W2-1/4-15	Ø 1/4" - 15 Meter - 1/4" NPS Arbeitsdruck 450 bar - Platzdruck 1.800 bar Working pressure 450 bar - burst pressure 1.800 bar	144,-		



Textil / Textile

Art.-Nr. Part-No.	Artikelbeschreibung Description	Listenpreis List price	Netto-Stückpreis bei Net unit price for
		€/Stück €/piece	1 Stück 1 piece
Ø 1/8" / DN3			
H-T-1/8-7.5-YE-SS	Ø 1/8" - 7.5 Meter - 1/4" NPS Arbeitsdruck 250 bar - Platzdruck 875 bar - Edelstahlanschlüsse - gelb Working pressure 250 bar - burst pressure 875 bar - stainless steel connections - yellow	76,-	
Ø 3/16" / DN5			
T-3/16-1.5-SS-NPE	Ø 3/16" - 1.5 Meter - 1/4" NPS (F) x 1/4" NPS (M) Arbeitsdruck 250 bar - Platzdruck 875 bar - Edelstahlanschlüsse - blau Working pressure 250 bar - burst pressure 875 bar - stainless steel connections - blue	36,-	
T-3/16-7.5-SS-NPE	Ø 3/16" - 7.5 Meter - 1/4" NPS Arbeitsdruck 250 bar - Platzdruck 875 bar - Edelstahlanschlüsse - blau Working pressure 250 bar - burst pressure 875 bar - stainless steel connections - blue	50,-	
T-3/16-7.5-YE-SS-NPE	Ø 3/16" - 7.5 Meter - 1/4" NPS Arbeitsdruck 250 bar - Platzdruck 875 bar - Edelstahlanschlüsse - gelb Working pressure 250 bar - burst pressure 875 bar - stainless steel connections - yellow		
T-3/16-10-SS-NPE	Ø 3/16" - 10 Meter - 1/4" NPS Arbeitsdruck 250 bar - Platzdruck 875 bar - Edelstahlanschlüsse - blau Working pressure 250 bar - burst pressure 875 bar - stainless steel connections - blue	54,-	
T-3/16-10-YE-SS-NPE	Ø 3/16" - 10 Meter - 1/4" NPS Arbeitsdruck 250 bar - Platzdruck 875 bar - Edelstahlanschlüsse - gelb Working pressure 250 bar - burst pressure 875 bar - stainless steel connections - yellow		
T-3/16-15-SS-NPE	Ø 3/16" - 15 Meter - 1/4" NPS Arbeitsdruck 250 bar - Platzdruck 875 bar - Edelstahlanschlüsse - blau Working pressure 250 bar - burst pressure 875 bar - stainless steel connections - blue	66,-	
T-3/16-15-YE-SS-NPE	Ø 3/16" - 15 Meter - 1/4" NPS Arbeitsdruck 250 bar - Platzdruck 875 bar - Edelstahlanschlüsse - gelb Working pressure 250 bar - burst pressure 875 bar - stainless steel connections - yellow		



Textil / Textile

Art.-Nr. Part-No.	Artikelbeschreibung Description	Listenpreis List price	Netto-Stückpreis bei Net unit price for
		€/Stück €/piece	
Ø 1/4" / DN6			
T-1/4-1.5-SS-3-NPE	Ø 1/4" - 1.5 Meter - 1/4" NPS (F) x 3/8" NPS (M) Arbeitsdruck 260 bar - Platzdruck 920 bar - Edelstahlanschlüsse - blau Working pressure 260 bar - burst pressure 920 bar - stainless steel connections - blue	42,-	
T-1/4-1.5-SS-NPE	Ø 1/4" - 1.5 Meter - 1/4" NPS (F) x 1/4" NPS (M) Arbeitsdruck 260 bar - Platzdruck 920 bar - Edelstahlanschlüsse - blau Working pressure 260 bar - burst pressure 920 bar - stainless steel connections - blue	38,-	
T-1/4-15-SS-NPE	Ø 1/4" - 15 Meter - 1/4" NPS Arbeitsdruck 260 bar - Platzdruck 920 bar - Edelstahlanschlüsse - blau Working pressure 260 bar - burst pressure 920 bar - stainless steel connections - blue	66,-	
T-1/4-15-YE-SS-NPE	Ø 1/4" - 15 Meter - 1/4" NPS Arbeitsdruck 260 bar - Platzdruck 920 bar - Edelstahlanschlüsse - gelb Working pressure 260 bar - burst pressure 920 bar - stainless steel connections - yellow		
Ø 3/8" / DN10			
T-3/8-15-SS-NPE	Ø 3/8" - 15 Meter - 3/8" NPS Arbeitsdruck 260 bar - Platzdruck 920 bar - Edelstahlanschlüsse - blau Working pressure 260 bar - burst pressure 920 bar - stainless steel connections - blue	118,-	
T-3/8-30-SS-NPE	Ø 3/8" - 30 Meter - 3/8" NPS Arbeitsdruck 260 bar - Platzdruck 920 bar - Edelstahlanschlüsse - blau Working pressure 260 bar - burst pressure 920 bar - stainless steel connections - blue	178,-	
Ø 1/2" / DN13			
T-1/2-15-SS-NPE	Ø 1/2" - 15 Meter - 1/2" NPS Arbeitsdruck 260 bar - Platzdruck 920 bar - Edelstahlanschlüsse - blau Working pressure 260 bar - burst pressure 920 bar - stainless steel connections - blue	340,-	
MA-EF-1/2-15-SS	Ø 1/2" - 15 Meter - 1/2" NPS - EASYFLEX Sehr flexibel - Arbeitsdruck 260 bar - Platzdruck 920 bar - Edelstahlanschlüsse - blau Very flexible - working pressure 260 bar - burst pressure 920 bar - stainless steel connections - blue	420,-	

1 AIRCOMBI

im Gewebeschutzschlauch
in protection hose



3

Gewebeschutzschlauch
Protection hose

2

Luftschlauch
Air hose



HD-Material- und Luftschlauch / HP-material and air hose

Pos.	Art.-Nr. Part-No.	Artikelbeschreibung Description	Listenpreis List price €/Stück €/piece	Netto-Stückpreis bei Net unit price for
1	HTH-T-1/8-7.5-SS	1/8" - 7.5 m - 1/4" NPS - SS	198,-	
	HTH-T-3/16-7.5-SS	3/16" - 7.5 m - 1/4" NPS - SS	198,-	
	HTH-T-3/16-7.5M-SS	3/16" - 7.5 m - M16x1.5 - SS		
	HTH-T-3/16-7.5J-SS	3/16" - 7.5 m - 1/2" JIC - SS		
	HTH-T-3/16-10-SS	3/16" - 10 m - 1/4" NPS - SS	252,-	
	HTH-T-3/16-10M-SS	3/16" - 10 m - M16x1.5-SS		
	HTH-T-3/16-10J-SS	3/16" - 10 m - 1/2" JIC - SS		
	HTH-T-3/16-15-SS	3/16" - 15 m - 1/4" NPS - SS	316,-	
	HTH-T-3/16-15M-SS	3/16" - 15 m - M16x1.5-SS		
	HTH-T-3/16-15J-SS	3/16" - 15 m - 1/2" JIC - SS		
	HTH-T-3/16-20-SS	3/16" - 20 m - 1/4" NPS - SS	378,-	

Luftschlauch / Air hose

Pos.	Art.-Nr. Part-No.	Artikelbeschreibung Description	Listenpreis List price €/Stück €/piece	Netto-Stückpreis bei Net unit price for
2	TPU20-6-AIR	6x10 mm - 20 bar Arbeitsdruck / working pressure (Rolle / Reel = 200 m)	5,80	

Gewebeschutzschlauch / Protection hose

Pos.	Art.-Nr. Part-No.	Artikelbeschreibung Description	Listenpreis List price €/Stück €/piece	Netto-Stückpreis bei Net unit price for
3	GW30-S	24-36 mm (Rolle/Reel = 50/100/250 m)	6,80	
	GW40-S	32-47 mm (Rolle/Reel = 50/100 m)	8,80	

1 500 bar

Hochdruck
High pressure



Rollenware & Anschlüsse
auf Anfrage
In bulk on reel & fittings
on request



Hochdruck Verbindungsrippel / High pressure nipples - 500 bar

Pos.	Art.-Nr. Part-No.	Artikelbeschreibung Description	Listenpreis List price €/Stück €/piece	Netto-Stückpreis bei Net unit price for
Stahl / Steel				
1	M1/4NXM1/4N	1/4" NPS (M) x 1/4" NPS (M)	7,-	
	M1/4NXM1/4N-K	1/4" NPS (M) x 1/4" NPS (M) - konisch / conical		
	M1/4NXM3/8N	1/4" NPS (M) x 3/8" NPS (M)		
	M16XM1/4N	M16x1.5 (M) x 1/4" NPS (M)	7,-	
	M16XM16	M16x1.5 (M) x M16x1.5 (M)		
	M3/8NXM16	3/8" NPS (M) x M16x1.5 (M)	7,-	
M3/8NXM3/8N	3/8" NPS (M) x 3/8" NPS (M)			

Edelstahl / Stainless steel

1	M1/4NXM1/4N-SS	1/4" NPS (M) x 1/4" NPS (M) - SS	16,-	
	M1/4NXM1/4N-K-SS	1/4" NPS (M) x 1/4" NPS (M) - konisch / conical - SS		
	M1/4NXM3/8N-SS	1/4" NPS (M) x 3/8" NPS (M) - SS		
	M16XM1/4N-SS	M16x1.5 (M) x 1/4" NPS (M) - SS	16,-	
	M16XM16-SS	M16x1.5 (M) x M16x1.5 (M) - SS		
	M3/8NXM16-SS	3/8" NPS (M) x M16x1.5 (M) - SS	16,-	
	M3/8NXM3/8N-SS	3/8" NPS (M) x 3/8" NPS (M) - SS		
	M3/8NXM1/2N-SS	3/8" NPS (M) x 1/2" NPS (M) - SS		17,80
	M1/2NXM1/2N-SS	1/2" NPS (M) x 1/2" NPS (M) - SS	17,80	

HEATING. MICRO. 4000.



MICRO STEUERUNG!

- Konstante Fix-Temperatur von 55°C unabhängig von Außentemperatur, Material und Düsengröße
- Sehr leichte Anwendung
- Direktanschluss an die Pumpe
- Kein separates Steuergerät/-kabel
- Einhaltung der VOC-Richtlinien
- Reduzierung der Viskosität
- Für wasser- und lösemittelhaltige Spritzmedien (Flammpunkt über 21°C)
- Auch für 2K-Materialien
- Adaptierbar an alle Airless-Geräte (Herstellervorgaben beachten)
- System steuert sich eigenständig – Keine Programmierung notwendig

MICRO CONTROL!

- Continual fix-temperature of 55°C independent of outside temperature, coating material and tip size
- Very easy to use
- Direct connection to the pump
- No separate control-unit/-cable
- In compliance with VOC-regulations
- Reduction of viscosity
- Suitable for solvent and water-based Material (flash point over 21°C)
- Also for 2-component material
- Adaptable to all Airless pumps (attend to manufacturer's specifications)
- System is independently self-controlled – No programming necessary

HEATING. ADJUSTABLE. 3000.



TEMPERATUR REGELBAR!

- Beheiztes Schlauch-System passend für alle Airless-Geräte
- Stufenlose Temperaturregelung von 20°- 70°C
- Einhaltung der VOC-Richtlinien (Stufe 2)
- Erwärmung des Spritzmediums reduziert die Viskosität
= Perfekte Beschichtung, auch an den Kanten
= Weniger/keine Lösungsmittel notwendig
= Wesentlich weniger Farbnebel
= Erhöhung der Zerstäubungsqualität und des Auftragswirkungsgrades
- Geeignet auch für 2-Komponenten-Materialien
- Bessere Verarbeitung höhervisköser Beschichtungsmaterialien
- Für wasser- und lösemittelhaltige Spritzmedien (Flammpunkt über 21°C)
- Beheiztes Schlauch-System ermöglicht den Einsatz kleinerer Airless-Pumpen und somit weniger Anschaffungs- und Betriebskosten

TEMPERATURE ADJUSTABLE!

- Heated hose system adaptable to all Airless pumps
- Infinitely adjustable temperature 20°- 70°C
- In compliance with VOC-regulations (level 2)
- Heating of material reduces viscosity of paint drastically
= Vastly improved coating-results, even at edges
= Little/no solvent needed to be added to paint
= Reduced overspray
= Increasing of diffusion quality and the application result
- Suitable for 2-component materials
- Better processing of high viscosity coating materials
- Suitable for solvent and water-based materials (flash point over 21°C)
- Heated hose system reduces the need for larger Airless units which means less investment, less expenses

Heizschlauchserie MICRO 4000 / Heated hose series MICRO 4000 - 250 bar			
Art.-Nr. Part-No.	Artikelbeschreibung Description	Listenpreis List price	Netto-Stückpreis bei Net unit price for
		€/Stück €/piece	
G-HH-7.5-55	Textil / Textile - 5/16" - 55°C - 7,5 m	2.400,-	
G-HH-15-55	Textil / Textile - 3/8" - 55°C- 15 m	2.900,-	

Heizschlauchserie 3000 / Heated hose series 3000 - 250 bar			
Art.-Nr. Part-No.	Artikelbeschreibung Description	Listenpreis List price	Netto-Stückpreis bei Net unit price for
		€/Stück €/piece	
G-HH-T-7.5-5/16	Textil / Textile - 5/16" - 7.5 m	2.400,-	
G-HH-T-15	Textil / Textile - 3/8" - 15 m	3.100,-	
G-HH-T-30	Textil / Textile - 3/8" - 30 m	3.400,-	

LIQUIDS & CLEANING PRODUCTS



Art.-Nr. / Part-No.
MA-TC200

**MASPRA Tip-Clean
Reinigungsflüssigkeit**

- Einfache und schnelle Reinigung ohne Hautkontakt
- 200 ml

**MASPRA Tip-Clean
cleaning liquid**

- Easy and fast cleaning without skin contact
- 200 ml

17,- € Listenpreis
List price



Art.-Nr. / Part-No.
MA-TC200-24

**MASPRA Tip-Clean
in der 24er Box**

- 24x 200 ml

**MASPRA Tip-Clean
in a box of 24 pieces**

- 24x 200 ml

378,- € Listenpreis
List price



Art.-Nr. / Part-No.
MA-TC1000

**MASPRA Tip-Clean
Reinigungsflüssigkeit**

- Nachfüllflasche
- 1.000 ml

**MASPRA Tip-Clean
cleaning liquid**

- Refill bottle
- 1.000 ml

24,- € Listenpreis
List price



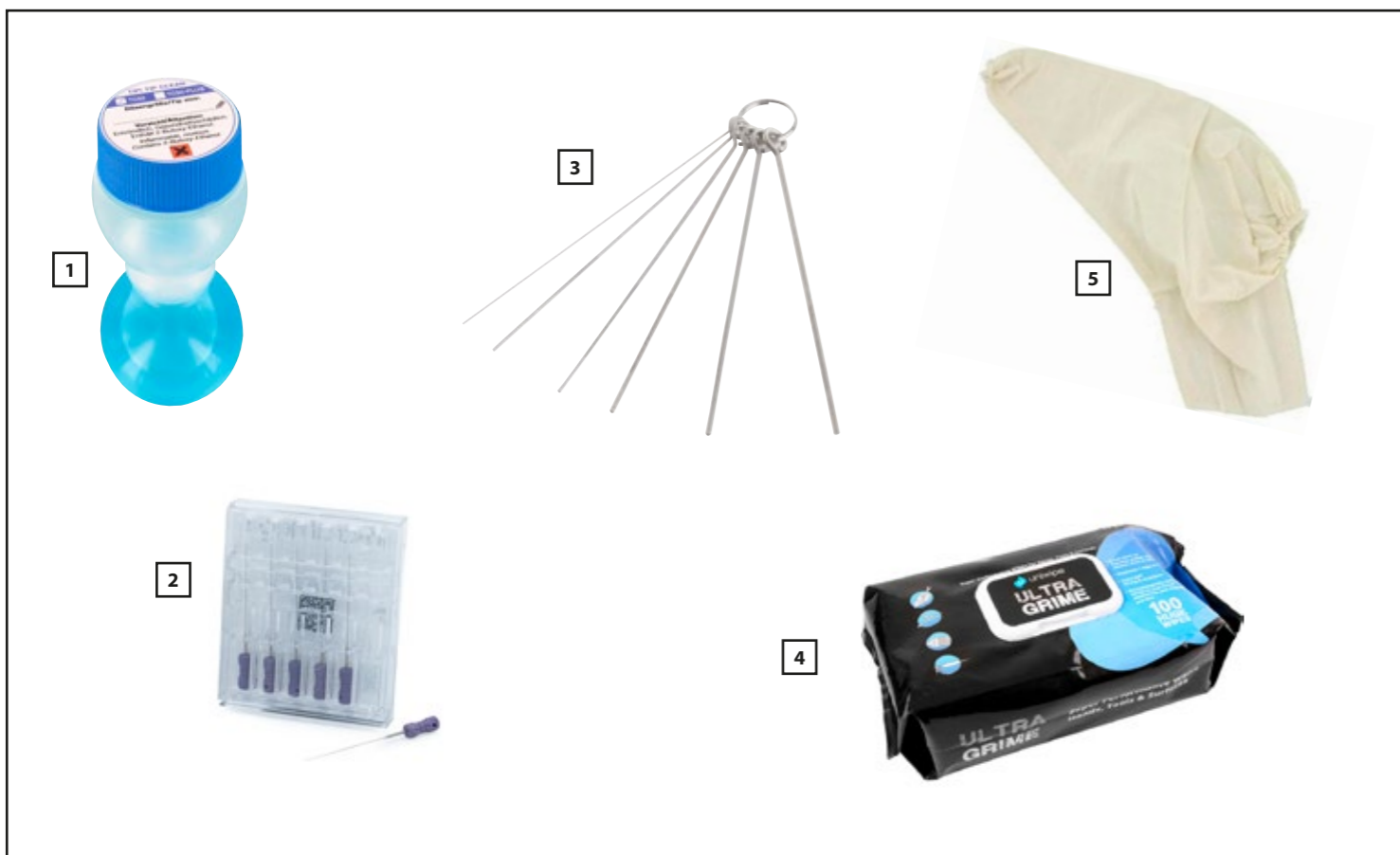

Pos.	Art.-Nr. Part-No.	Artikelbeschreibung Description	Listenpreis List price	Netto-Stückpreis bei Net unit price for
Düsenreinigung / TIP cleaning				
1	TC50	TIP-Clean - 50 ml	11,-	
Reinigungsnadeln / Cleaning broaches				
			€/Stück €/piece	
2	DRN-10/31-6	Ø10 / L 31 mm (6x)	19,-	
3	B-NS6	Ring mit 6 Nadeln / Ring with 6 broaches	3,40	
ULTRA GRIME				
			€/Stück €/piece	
4	ULTRA-G	Reinigungstücher für Hände, Werkzeuge und Oberflächen Cleaning wipes for hands, tools and surfaces	23,-	
Pistolenschutz E-Statik / Gun cover e-static				
			€/Stück €/piece	
5	ESTA-WA-LB	Handschuh / Glove	7,-	
	ESTA-100	Handschuh / Glove - TYVEK	11,40	

OPTION
PRIVATE LABEL

Art.-Nr. / Part-No.
MA-TM-05
**MASPRA Mesamoll
Throat Sealing Liquid**
Trennmittel - 500 ml
Separating fluid - 500 ml
18,- € Listenpreis
List price



Art.-Nr. / Part-No.
MA-TM-5000
**MASPRA Mesamoll
Throat Sealing Liquid**
Trennmittel - 5.000 ml
Separating fluid - 5.000 ml
152,- € Listenpreis
List price

Art.-Nr. / Part-No.
GR245423
**ASM Pump Life
1.000 ml**
Konservierungsmittel
Preserving agent
24,- € Listenpreis
List price



Art.-Nr. / Part-No.
GR245425
**ASM oil
1.000 ml**
Hydrauliköl
Hydraulic fluid
38,- € Listenpreis
List price

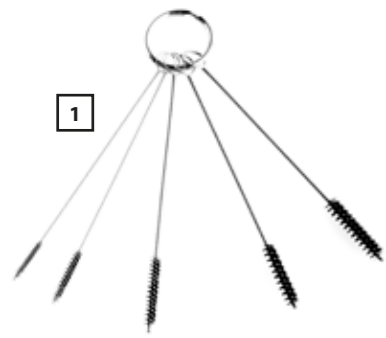

1



2



3



4

Pos.	Art.-Nr. Part-No.	Artikelbeschreibung Description	Listenpreis List price	Netto-Stückpreis bei Net unit price for
			€/Stück €/piece	
Bürsten / Brushes				
1	B-SB5	Bürstenreinigungs-Set 5 teilig Brush cleaning set 5 parts	10,-	
2	B-001	Reinigungsbürste / Cleaning brush	4,20	
3	B-10	Reinigungsbürste - 300 mm - 100 mm - 15 mm Cleaning brush - 300 mm - 100 mm - 15 mm	3,40	
	B-11	Reinigungsbürste - 155 mm - 55 mm - 10 mm Cleaning brush - 155 mm - 55 mm - 10 mm		
	B-12	Reinigungsbürste - 230 mm - 80 mm - 12 mm Cleaning brush - 230 mm - 80 mm - 12 mm		
	B-13	Reinigungsbürste - 155 mm - 55 mm - 10 mm - konisch Cleaning brush - 155 mm - 55 mm - 10 mm - conical		
4	B-14	Reinigungspinsel / Cleaning brush	3,40	

Art.-Nr. / Part-No.
MA-BR-SET-17

MASPRA
Bürstenreinigungs-Set
• 17 teilig

MASPRA
brush cleaning set
• 17 parts

20,- € Listenpreis
List price



Art.-Nr. / Part-No.
MA-BR-SET-17-10

MASPRA
Bürstenreinigungs-Set
in der 10er-Box
• 10x Bürsten-Set

MASPRA
brush cleaning set
in a box of 10 pieces
• 10x brush set

140,- € Listenpreis
List price



Art.-Nr. / Part-No.
MA-B-SB5

MASPRA
Bürstenreinigungs-Set
• 5 teilig

MASPRA
brush cleaning set
• 5 parts

8,- € Listenpreis
List price

Art.-Nr. / Part-No.

MA-KIT-AL**MASPRA Kit "Airless"**

- Universal Tragetasche
- Airless Pistole 500 bar - 7/8"
- HD-Schlauch 1/4" - 15 m
- Schlauchpeitsche 3/16" - 1.5 m
- MASPRA Universal Düsenhalter & Düsen (411 & 521)
- Düsenverlängerung 30 cm & Kniegelenk
- Je 10x Einsteckfilter gelb, rot & weiß
- TIP-Clean 200 ml

MASPRA kit "Airless"

- Universal shoulder bag
- Airless gun 500 bar - 7/8"
- HP-hose 1/4" - 15 m
- Hose whip 3/16" - 1.5 m
- MASPRA Universal tip base & tips (411 & 521)
- Pole extension 30 cm & angle head
- Gun filter yellow, red & white (10 of each)
- TIP-Clean 200 ml

400,- €Listenpreis
List price

Art.-Nr. / Part-No.

MA-KIT-AL-TUBE**MASPRA Kit "Innenbeschichtung"**

- Universal Tragetasche
- Airless Pistole 250 bar - 7/8"
- HD-Schlauch 3/16" - 7.5 m
- Aufnahmeadapter 7/8"
- Flexible Verlängerung 80 cm
- Rundstrahldüse R11

MASPRA kit "tube coating"

- Universal shoulder bag
- Airless gun 250 bar - 7/8"
- HP-hose 3/16" - 7.5 m
- Adapter 7/8"
- Flexible tube 80 cm
- Round jet tip R11

280,- €Listenpreis
List price

Art.-Nr. / Part-No.

MA-KIT-AC

MASPRA Kit "AirCombi"

- Universal Tragetasche
- AirCombi Pistole 250 bar mit blauer Luftkappe & Düse "W" 411
- Langes Filtergehäuse
- AirCombi Schlauch 3/16" - 7.5 m
- Rote Luftkappe & Düse "W" 513
- Je 10x Einsteckfilter gelb & rot
- TIP-Clean 50 ml

MASPRA kit "AirCombi"

- Universal shoulder bag
- AirCombi gun 250 bar with blue AirCap & tip "W" 411
- Long filter housing
- AirCombi hose 3/16" - 7.5 m
- Red AirCap & tip "W" 513
- Gun filter yellow & red (10 of each)
- TIP-Clean 50 ml

780,- € Listenpreis
List price



Art.-Nr. / Part-No.

MA-KIT-CLEAN

MASPRA Kit "Reinigung"

- Universal Tragetasche
- Einwegoverall Gr. XXL
- 5x Schutzmaske KN95 (FFP2)
- Reinigungstücher
- TIP-Clean 200 ml
- Reinigungslösung 1.000 ml
- Trennmittel 500 ml
- Bürstenreinigungs-Set 17 tlg.

MASPRA kit "cleaning"

- Universal shoulder bag
- Single use overall size XXL
- 5x face mask KN95 (FFP2)
- Cleaning wipes
- TIP-Clean 200 ml
- Cleaning liquid 1.000 ml
- Separating fluid 500 ml
- Brush cleaning set 17 parts

160,- € Listenpreis
List price



Art.-Nr. / Part-No.

MA-KIT-AIR-210**MASPPA Kit "Air 210"**

- Universal Tragetasche
- Luftpistole mit Düse & Nadel 1.5 mm
- Luftkappe, Düse & Nadel 2.5 mm
- Niederdruck-Tandemschlauch 7.5 m
- Filtergehäuse
- Je 10x Filter blau & weiß
- Bürstenreinigungs-Set 5 tlg.

MASPPA kit "Air 210"

- Universal shoulder bag
- Air gun with nozzle & needle 1.5 mm
- AirCap, nozzle & needle 2.5 mm
- Low pressure twin hose 7.5 m
- Filter housing
- Filter blue & white (10 of each)
- Brush cleaning set 5 parts

360,- €Listenpreis
List price

Art.-Nr. / Part-No.

MA-KIT-AIR-413**MASPPA Kit "Air 413"**

- Universal Tragetasche
- Luftpistole mit Düse & Nadel 1.5 mm
- Luftkappe, Düse & Nadel 2.5 mm
- Fließbecher 600 ml
- Schnellkupplung 1/4"
- Luftregelventil mit Manometer 1/4"
- 10x Filter für Fließbecher
- 25x Einfülltrichter inkl. Filter
- Bürstenreinigungs-Set 5 tlg.

MASPPA kit "Air 413"

- Universal shoulder bag
- Air gun with nozzle & needle 1.5 mm
- AirCap, nozzle & needle 2.5 mm
- Gravity cup 600 ml
- Quick coupling 1/4"
- Air flow control valve with gauge 1/4"
- 10x Filter for gravity cup
- 25x Feed hopper with sieve
- Brush cleaning set 5 parts

360,- €Listenpreis
List price

PRONA
Drucktanks / Pressure pots
122 - 125



ASM
142 - 145

PRONA
Doppelmembranpumpen / Double diaphragm pumps
126 - 127



GRACO CED
146 - 149

PRONA
Pneumatische Rührwerke / Pneumatic agitators
128 - 131



GRACO Heavy Duty
150 - 151

PRONA
Luftpistolen / Air guns
132 - 135



GRACO Finishing
152 - 155

PRONA
Automatik Pistolen / Automatic guns
136 - 137



WAGNER
156 - 157

AIRGUNSA & ANEST IWATA
Luftpistolen / Air guns
138 - 139



WIWA & KREMLIN
158 - 159

Niederdruck Zubehör
Low pressure accessories
140 - 141



FORMECO
160 - 161

PRONA. TANKS.

Drucktanks aus Aluminium oder Edelstahl.

- Erhältlich in 2/5/10/20/40/60 Ltr.
- Mit pneumatischem, manuellem oder ohne Rührwerk
- Inkl. Edelstahl Einsatztopf (ab 5 Ltr.)
- Bis max. 3 bar (mit Sicherheitsventil)
- Fahrbar durch einklappbare Räder (nur Alu Version ab 10 Ltr.)
- Manometer für Materialspritzdruck

Pressure tanks made of aluminium or stainless steel.

- Available in 2/5/10/20/40/60 Ltr.
- With pneumatic, manual or without agitator
- Incl. stainless steel inner tank (for 5 ltr. and more)
- Up to max. 3 bar (with safety valve)
- Mobile by the use of foldable tires (only alu version starting from 10 ltr.)
- Gauge for material pressure

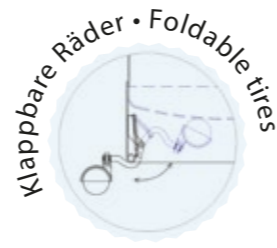

ohne Rührwerk
without agitator



mit pneumatischem Rührwerk
with pneumatic agitator



mit manuellem Rührwerk
with manual agitator

PRONA

Art.-Nr. Part-No.	Artikelbeschreibung Description	Listenpreis List price	Netto-Stückpreis bei Net unit price for
		€/Stück €/piece	

Drucktanks - Aluminium / Pressure tanks - aluminum

2 Liter

RT-2E	Aluminium - 2 Ltr. - Hakengriff / Handle hook	196,-	
RC-2E	Aluminium - 2 Ltr. - Rundgriff / Handle round	248,-	



Alle Artikel und Ersatzteile lieferbar.
Rabatt auf Anfrage.
All products and spare parts available.
Conditions on request.
www.gemini-airless.de/prona

PRONA

Art.-Nr. Part-No.	Artikelbeschreibung Description	Listenpreis List price	Netto-Stückpreis bei Net unit price for
		€/Stück €/piece	

Drucktanks - Aluminium / Pressure tanks - aluminum

5 Liter

RT-5E	ohne Rührwerk / without agitator - 5 Ltr.	368,-	
RT-5M	mit manuellem Rührwerk / with manual agitator - 5 Ltr.	485,-	
RT-5A	mit pneumatischem Rührwerk / with pneumatic agitator - 5 Ltr.	595,-	

10 Liter

RT-10E	ohne Rührwerk / without agitator - 10 Ltr.	570,-	
RT-10M	mit manuellem Rührwerk / with manual agitator - 10 Ltr.	610,-	
RT-10A	mit pneumatischem Rührwerk / with pneumatic agitator - 10 Ltr.	940,-	

20 Liter

RT-20E	ohne Rührwerk / without agitator - 20 Ltr.	798,-	
RT-20M	mit manuellem Rührwerk / with manual agitator - 20 Ltr.	890,-	
RT-20A	mit pneumatischem Rührwerk / with pneumatic agitator - 20 Ltr.	1.170,-	

40 Liter

RT-40E	ohne Rührwerk / without agitator - 40 Ltr.	960,-	
RT-40A	mit pneumatischem Rührwerk / with pneumatic agitator - 40 Ltr.	1.290,-	

60 Liter

RT-60E	ohne Rührwerk / without agitator - 60 Ltr.	1.120,-	
RT-60A	mit pneumatischem Rührwerk / with pneumatic agitator - 60 Ltr.	1.590,-	



PRONA

Art.-Nr. Part-No.	Artikelbeschreibung Description	Listenpreis List price €/Stück €/piece	Netto-Stückpreis bei Net unit price for
----------------------	------------------------------------	---	--

Drucktanks - Edelstahl / Pressure tanks - stainless steel

5 Liter

RT-5ES	ohne Rührwerk / without agitator - 5 Ltr.	760,-	
RT-5AS	mit pneumatischem Rührwerk / with pneumatic agitator - 5 Ltr.	1.020,-	

10 Liter

RT-10ES	ohne Rührwerk / without agitator - 10 Ltr.	1.190,-	
RT-10AS	mit pneumatischem Rührwerk / with pneumatic agitator - 10 Ltr.	1.636,-	

20 Liter

RT-20AS	mit pneumatischem Rührwerk / with pneumatic agitator - 20 Ltr.	1.960,-	
---------	--	---------	--

40 Liter

RT-40AS	mit pneumatischem Rührwerk / with pneumatic agitator - 40 Ltr.	2.010,-	
---------	--	---------	--

1



2



PRONA

Pos.	Art.-Nr. Part-No.	Artikelbeschreibung Description	Listenpreis List price €/Stück €/piece	Netto-Stückpreis bei Net unit price for
------	----------------------	------------------------------------	---	--

Einsatzbehälter - Edelstahl / Inner tank - stainless steel

1	RT-IT-5-SS	5 Ltr.	109,-	
	RT-IT-10-SS	10 Ltr.	140,-	
	RT-IT-20-SS	20 Ltr.	200,-	
	RT-IT-40-SS	40 Ltr.	230,-	
	RT-IT-60-SS	60 Ltr.	320,-	

Einweg Plastik-Einsatz / Disposable plastic bag

2	RT-10#2-2	10 Ltr. (1 Stück / 1 piece)	5,80	
	RT-20#2-2	20 Ltr. (1 Stück / 1 piece)	7,80	
	RT-40#2-2	40 Ltr. (1 Stück / 1 piece)	10,40	
	RT-60#2-2	60 Ltr. (1 Stück / 1 piece)	11,80	

PRONA. PUMPS.

Pneumatische Doppelmembranpumpen

- Erhältlich aus Aluminium, Polypropylen oder Edelstahl
- Von 36 bis zu 580 Ltr./Min.
- 3/8" bis zu 2"

Pneumatic double diaphragm pumps

- Available made of aluminum, polypropylene or stainless steel
- From 36 up to 580 ltr./min.
- From 3/8" up to 2"



1
Aluminium



2
Polypropylene



3
Edelstahl
Stainless steel

PRONA				
Pos.	Art.-Nr. Part-No.	Artikelbeschreibung Description	Listenpreis List price €/Stück €/piece	Netto-Stückpreis bei Net unit price for
Aluminium / Aluminum				
1	R-15	3/8" – 36 Ltr./min. – Aluminium	520,-	
	R-20	1/2" – 50 Ltr./min. – Aluminium	710,-	
	R-31	1" – 180 Ltr./min. – Aluminium	1.180,-	
	R-41	1 1/2" – 300 Ltr./min. – Aluminium	2.100,-	
	R-51	2" – 580 Ltr./min. – Aluminium	2.640,-	
Polypropylene / Polypropylene				
2	PP-20	1/2" – 50 Ltr./min. – Polypropylene	910,-	



4 PRONA
R-15 Set

6 UNIVERSAL
Fahrwagen
Trolley

5 PRONA
R-1500-PLUS

7
Aluminium

8
Edelstahl
Stainless steel



PRONA				
Pos.	Art.-Nr. Part-No.	Artikelbeschreibung Description	Listenpreis List price €/Stück €/piece	Netto-Stückpreis bei Net unit price for
Edelstahl / Stainless steel				
3	RS-15-SS	3/8" – 36 Ltr./min. – Edelstahl / stainless steel	790,-	
	RS-20-SS	1/2" – 50 Ltr./min. – Edelstahl / stainless steel	990,-	
	RS-31-SS	1" – 180 Ltr./min. – Edelstahl / stainless steel	1.890,-	
	RS-41-SS	1 1/2" – 300 Ltr./min. – Edelstahl / stainless steel	3.770,-	
	RS-51-SS	2" – 580 Ltr./min. – Edelstahl / stainless steel	6.900,-	
SprayPacks				
4	R-1500	R-15 Pumpe inkl. Ansaugsystem - Auf Ständer R-15 Pump incl. suction system - on stand	590,-	
5	R-1500-PLUS	R-15 Pumpe inkl. Ansaugsystem & Rührwerk - Auf Ständer R-15 Pump incl. suction system & agitator - on stand	860,-	
Zubehör / Accessories				
6	R-T-DDP	Universal Fahrwagen inkl. Aufnahme für Doppelmembranpumpen Universal trolley incl. support for double diaphragm pumps	380,-	
7	RPR-5	Materialdruckregler - 3/8" - 0-6 bar - 2 Ltr./min. Fluid regulator - 3/8" - 0-6 bar - 2 Ltr./min.	186,-	
8	RPR-5-SS	Materialdruckregler - 3/8" - 0-6 bar - 2 Ltr./min. - Edelstahl Fluid regulator - 3/8" - 0-6 bar - 2 Ltr./min. - stainless steel	270,-	

PRONA. AGITATORS.

Pneumatische Rührwerke

- Für Gebinde bis 200 Liter
- Von 60 bis zu 370 Watt
- Von 1.420 bis 3.000 U/min

Pneumatic agitators

- For compound units up to 200 liters
- From 60 up to 370 watts
- From 1.420 up to 3.000 RPM



PRONA				
Pos.	Art.-Nr. Part-No.	Artikelbeschreibung Description	Listenpreis List price €/Stück €/piece	Netto-Stückpreis bei Net unit price for
Mini				
1	RB-MN	Mini Rührwerk - max. 10 Ltr. Gebinde Mini agitator - max. 10 ltr. compound units	344,-	
2	RB-MN-1A	Mini Rührwerk - max. 10 Ltr. Gebinde - inkl. Universal Adapter Mini agitator - max. 10 ltr. compound units - incl. universal adapter	368,-	

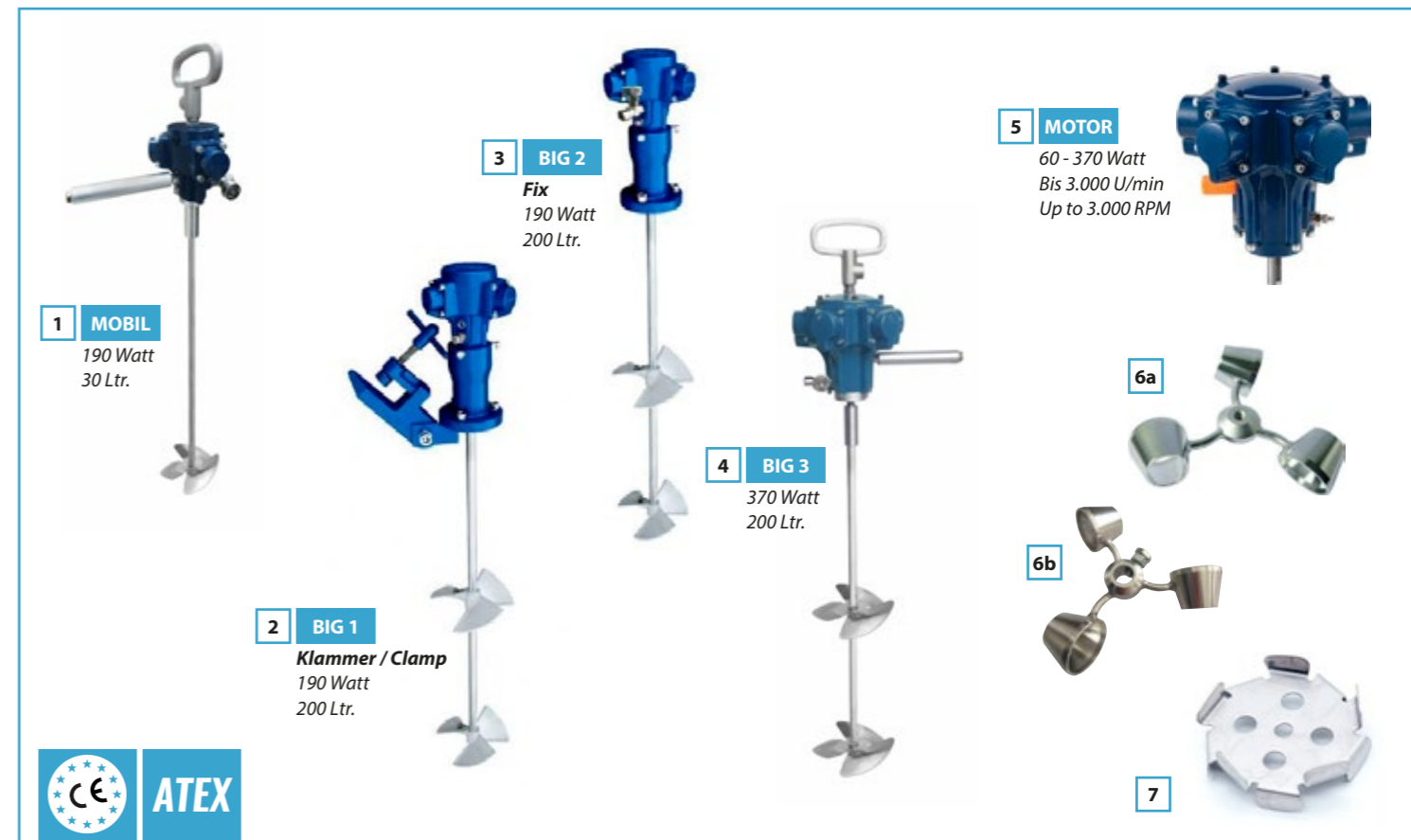

PRONA				
Pos.	Art.-Nr. Part-No.	Artikelbeschreibung Description	Listenpreis List price €/Stück €/piece	Netto-Stückpreis bei Net unit price for
Mobil				
1	RB-MA	Mobiles Handrührwerk - max. 30 Ltr. Gebinde Mobile hand agitator - max. 30 ltr. compound units	468,-	
Big				
2	RB-200-KLEMM	Rührwerk inkl. Klemmbefestigung - 200 Ltr. Gebinde - M30 Motor Agitator with clamp fixation - 200 ltr. compound units - M30 motor	398,-	
3	RB-200-FIX	Rührwerk mit FIX Befestigung - 200 Ltr. Gebinde - M30 Motor Agitator with fixation - 200 ltr. compound units - M30 motor		
4	RB-200-MA	Handrührwerk - 200 Ltr. Gebinde - M40 Motor Hand agitator - 200 ltr. compound units - M40 motor	540,-	
Luftmotoren / Air motors				
	RB-M10	M10 - 60 Watt - 2.200 U/min / 2.200 RPM	240,-	
	RB-M20	M20 - 120 Watt - 3.000 U/min / 3.000 RPM	250,-	
5	RB-M30	M30 - 190 Watt - 2.500 U/min / 2.500 RPM	320,-	
	RB-M40	M40 - 300 Watt - 2.100 U/min / 2.100 RPM	560,-	
	RB-M50	M50 - 370 Watt - 1.420 U/min / 1.420 RPM	660,-	
Rührflügel / Mixing propeller				
6a	RFD80	Rührflügel - Edelstahl / Propeller - stainless steel - Ø80 - M8	68,-	
	RFD150	Rührflügel - Edelstahl / Propeller - stainless steel - Ø150 - M8	96,-	
6b	RFD150-3	Rührflügel Ø150 - Edelstahl - ohne Gewinde - mit Fixierschraube - Ø Loch 15 mm Propeller - Ø150 - stainless steel - without threading - with fixation - Ø hole 15 mm	96,-	
7	RFD85	Rührflügel - Edelstahl / Propeller - stainless steel - Ø85	18,-	

PRONA. AGITATOR. LIFTS.

Pneumatische Rührwerke

- Erhältlich auf Bodenplatte oder auf Fahrwagen
- Verfügbar mit oder ohne pneumatischem Lift

Pneumatic agitators

- Available on fixed plate or on trolley
- With or without pneumatic lift



1 BASE

190 Watt
0-3.000 U./Min. / RPM

3 AIR-LIFT

190 Watt
0-3.000 U./Min. / RPM

2 AIR-LIFT

190 Watt
0-3.000 U./Min. / RPM

4 COVER

20 Ltr. - Ø 310 mm
Edelstahl
Stainless steel



PRONA

Pos.	Art.-Nr. Part-No.	Artikelbeschreibung Description	Listenpreis List price €/Stück €/piece	Netto-Stückpreis bei Net unit price for
Auf Fahrwagen - ohne Lift / On trolley - without lift				
1	RB-BA-T	Komplett auf Fahrwagen - max. 30 Ltr. Gebinde Complete on trolley - max 30. ltr. compound units	640,-	
Auf Bodenplatte - mit Lift / On fixed plate - with lift				
2	RB-BA-AIR	Komplett auf Bodenplatte - max. 30 Ltr. Gebinde Complete on fixed plate - max 30. ltr. compound units	980,-	
Auf Fahrwagen - mit Lift / On trolley - with lift				
3	RB-BA-AIR-T	Komplett auf Fahrwagen - max. 30 Ltr. Gebinde Complete on trolley - max 30. ltr. compound units	1.020,-	
Deckeinheit / Cover unit				
4	RB-COVER-20	Inkl. Rührwerk - 20 Ltr. Gebinde - Ø 310 mm - Edelstahl With agitator - 20 ltr. compound units - Ø 310 mm - stainless steel	600,-	

PRONA

Pos.	Art.-Nr. Part-No.	Artikelbeschreibung Description	Listenpreis List price €/Stück €/piece	Netto-Stückpreis bei Net unit price for
Auf Bodenplatte - ohne Lift / On fixed plate - without lift				
1	RB-BA	Komplett auf Bodenplatte - max. 30 Ltr. Gebinde Complete on fixed plate - max 30. ltr. compound units	600,-	

LOW PRESSURE PAINT SPRAY GUNS



PRONA				
Pos.	Art.-Nr. Part-No.	Artikelbeschreibung Description	Listenpreis List price	Netto-Stückpreis bei Net unit price for
			€/Stück €/piece	

R-210				
1	R-210P-xx	Luftpistole mit Düse / Air gun with tip 0.8/1.0/1.2/1.5/1.8/2.0/2.5 mm	180,-	
2	R-210P-N-xx	Düse & Nadel / Nozzle & needle 0.8/1.0/1.2/1.5/1.8/2.0/2.5 mm	44,-	
3	R-210P-C-G2P	Luftkappe / AirCap - G2P - 0.8/1.0/1.2 mm	34,-	
	R-210P-C-K2	Luftkappe / AirCap - K2 - 1.5/1.8 mm		
	R-210P-C-R2	Luftkappe / AirCap - R2 - 2.0 mm		
	R-210P-C-W2	Luftkappe / AirCap - W2 - 2.5 mm		
4	G-SET-R-210P	Luftpistolen-Drucktank-Set Drucktank 2 Ltr., Schlauchpaket 1/4" - 2,5 m, Luftpistole R-210P - 1.5 mm Air gun pressure tank set Pressure tank 2 ltr., hose set 1/4" - 2,5 m, air gun R-210P - 1.5 mm	400,-	

Model	R-210P-08	R-210P-10	R-210P-12	R-210P-15	R-210P-18	R-210P-20	R-210P-25
Luftbedarf Air consumption	560 l/min		330 l/min		360 l/min		
Material Durchfluss Fluid output	400 ml/min		500 ml/min	270 ml/min	330 ml/min	400 ml/min	500 ml/min
Gewicht Weight	536 g						
Anschlussgewinde Fluid inlet thread	3/8"						
Luftanschluss Air inlet thread	1/4"						



PRONA				
Pos.	Art.-Nr. Part-No.	Artikelbeschreibung Description	Listenpreis List price €/Stück €/piece	Netto-Stückpreis bei Net unit price for
R-413				
1	R-413G-xx	Luftpistole mit Düse / Air gun with tip 1.2/1.3/1.4/1.5/1.6/1.8/2.0/2.5 mm	180,-	
2	R-413G-N-xx	Düse & Nadel / Nozzle & needle 1.2/1.3/1.4/1.5/1.6/1.8/2.0/2.5 mm	44,-	
3	R-413G-C-LV2	Luftkappe / AirCap - LV2 - 1.2/1.3/1.4/1.5/1.6/1.8/2.0 mm	34,-	
	R-413G-C-W2	Luftkappe / AirCap - W2 - 2.5 mm		
4	CUP-M16-QUICK	Fließbecher mit Schnellkupplung / Gravity cup with quick coupling M16x1.5 (M) - 600 ml	18,-	
	R-413G-SET	Reparatur-Set / Fixing-Set		

Model	R-413G-12	R-413G-13	R-413G-14	R-413G-15	R-413G-16	R-413G-18	R-413G-20	R-413G-25	
Luftbedarf Air consumption								320 l/min	360 l/min
Material Durchfluss Fluid output	160 ml/min	180 ml/min	215 ml/min	270 ml/min	275 ml/min	330 ml/min	410 ml/min	510 ml/min	
Gewicht Weight	464 g								
Anschlussgewinde Fluid inlet thread	M16x1.5								
Luftanschluss Air inlet thread	1/4"								

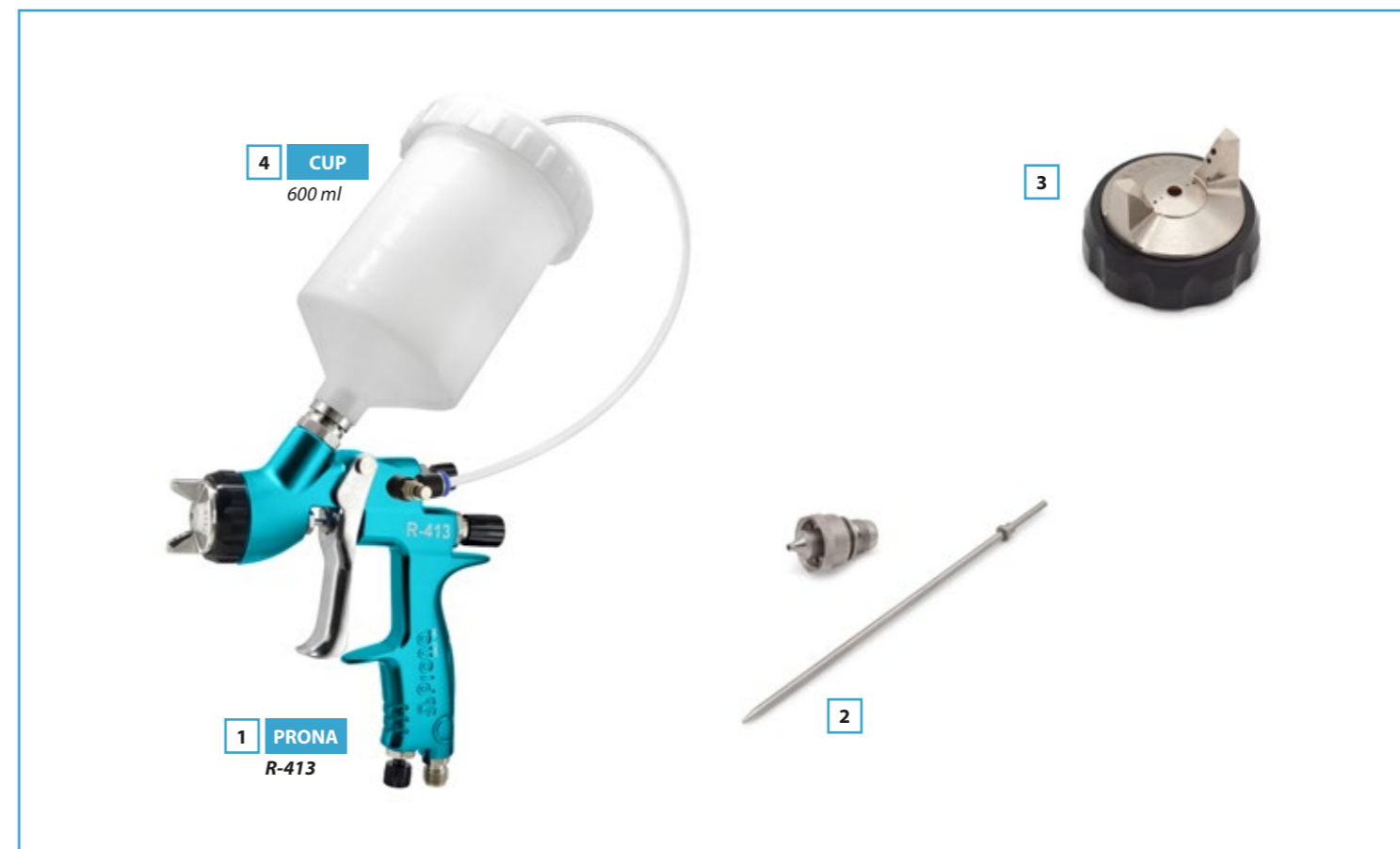

PRONA				
Pos.	Art.-Nr. Part-No.	Artikelbeschreibung Description	Listenpreis List price €/Stück €/piece	Netto-Stückpreis bei Net unit price for
R-413				
1	R-413G-IP-xx	Luftpistole mit Düse und Druckbecher / Air gun with tip and pressure assisted cup 1.2/1.3/1.4/1.5/1.6/1.8/2.0/2.5 mm	240,-	
2	R-413G-N-xx	Düse & Nadel / Nozzle & needle 1.2/1.3/1.4/1.5/1.6/1.8/2.0/2.5 mm	44,-	
3	R-413G-C-LV2	Luftkappe / AirCap - LV2 - 1.2/1.3/1.4/1.5/1.6/1.8/2.0 mm	34,-	
	R-413G-C-W2	Luftkappe / AirCap - W2 - 2.5 mm		
4	RC-6M-P	Druckbecher / Pressure assisted cup M16x1.5 (M) - 600 ml	28,-	
	R-413G-SET	Reparatur-Set / Fixing-Set		

Model	R-413G-IP-12	R-413G-IP-13	R-413G-IP-14	R-413G-IP-15	R-413G-IP-16	R-413G-IP-18	R-413G-IP-20	R-413G-IP-25	
Luftbedarf Air consumption								320 l/min	360 l/min
Material Durchfluss Fluid output	160 ml/min	180 ml/min	215 ml/min	270 ml/min	275 ml/min	330 ml/min	410 ml/min	510 ml/min	
Gewicht Weight	517 g								
Anschlussgewinde Fluid inlet thread	M16x1.5								
Luftanschluss Air inlet thread	1/4"								

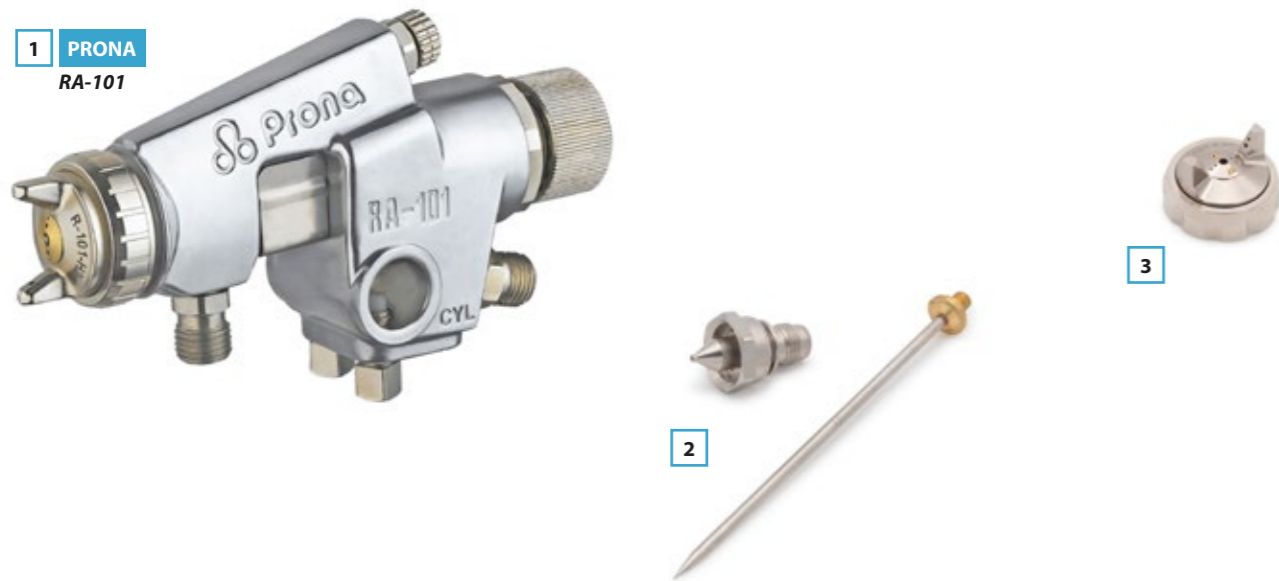

PRONA

Pos.	Art.-Nr. Part-No.	Artikelbeschreibung Description	Listenpreis List price €/Stück €/piece	Netto-Stückpreis bei Net unit price for
RA-101				
1	RA-101-xx	Pistole mit Düse / Gun with tip - 0.8/1.0/1.3/1.5/1.8 mm	300,-	
2	RA-101-N-xx	Düse & Nadel / Nozzle & needle 0.8/1.0/1.3/1.5/1.8 mm	44,-	
3	RA-101-C-E2P	Luftkappe / AirCap - E2P - 0.8/1.0 mm	34,-	
	RA-101-C-H2	Luftkappe / AirCap - H2 - 1.3/1.5 mm		
	RA-101-C-N2	Luftkappe / AirCap - N2 - 1.8 mm		

Model	RA-101-08	RA-101-10	RA-101-13	RA-101-15	RA-101-18
Luftbedarf Air consumption	270 l/min		260 l/min		190 l/min
Material Durchfluss Fluid output	150 ml/min	200 ml/min	250 ml/min	270 ml/min	310 ml/min
Gewicht Weight	475 g				
Anschlussgewinde Fluid inlet thread	1/4"				
Luftanschluss Air inlet thread	1/4"				



PRONA

Pos.	Art.-Nr. Part-No.	Artikelbeschreibung Description	Listenpreis List price €/Stück €/piece	Netto-Stückpreis bei Net unit price for
RA-200				
1	RA-200-xx	Pistole mit Düse / Gun with tip - 1.2/1.5/1.8/2.0/2.5 mm	320,-	
2	RA-200-N-xx	Düse & Nadel / Nozzle & needle 1.2/1.5/1.8/2.0/2.5 mm	44,-	
3	RA-200-C-G2P	Luftkappe / AirCap - G2P - 1.2 mm	34,-	
	RA-200-C-K2	Luftkappe / AirCap - K2 - 1.5/1.8 mm		
	RA-200-C-R2	Luftkappe / AirCap - R2 - 2.0 mm		
	RA-200-C-W2	Luftkappe / AirCap - W2 - 2.5 mm		

Model	RA-200-12	RA-200-15	RA-200-18	RA-200-20	RA-200-25
Luftbedarf Air consumption	560 l/min	330 l/min		360 l/min	
Material Durchfluss Fluid output	400 ml/min	270 ml/min	330 ml/min	400 ml/min	500 ml/min
Gewicht Weight	550 g				
Anschlussgewinde Fluid inlet thread	3/8"				
Luftanschluss Air inlet thread	1/4"				



1 AIRGUNSA AZ3

2

3

4 CUP 600 ml

Alle Artikel und Ersatzteile lieferbar.
Rabatt auf Anfrage
All products and spare parts available.
Conditions on request.
www.gemini-airless.de/airgunsa

AIRGUNSA

Pos.	Art.-Nr. Part-No.	Artikelbeschreibung Description	Listenpreis List price	Netto-Stückpreis bei Net unit price for
------	-------------------	---------------------------------	------------------------	---

AZ3				
1	W0SPG81AGxxC	Luftpistole mit Düse / Air gun with tip 1.0/1.3/1.5/1.8/2.0/2.5/2.8/3.0/3.5 mm	122,-	
2	W201013xx	Düse & Nadel / Nozzle & needle 1.0/1.3/1.5/1.8/2.0/2.5/2.8/3.0/3.5 mm	26,50	
3	W2CAP80AG15	Luftkappe / AirCap - 1.0/1.3/1.5 mm	36,50	
	W2CAP80AG18	Luftkappe / AirCap - 1.8/2.0 mm		
	W2CAP80AG25	Luftkappe / AirCap - 2.5 mm		
	W2CAP80AG30	Luftkappe / AirCap - 2.8/3.0 mm		
	W2CAP80AG35	Luftkappe / AirCap - 3.5 mm		
4	W0012820100	Fließbecher / Gravity cup - PCG-6P 1/4" (M) - 600 ml	20,-	

Model	Ø 1.0	Ø 1.3	Ø 1.5	Ø 1.8	Ø 2.0	Ø 2.5	Ø 2.8	Ø 3.0	Ø 3.5
Luftbedarf Air consumption	200 l/min			215 l/min		280 l/min	300 l/min		
Material Durchfluss Fluid output	80 ml/min	140 ml/min	160 ml/min	250 ml/min	300 ml/min	450 ml/min	540 ml/min	560 ml/min	600 ml/min
Gewicht Weight	500 g								
Anschlussgewinde Fluid inlet thread	1/4"								
Luftanschluss Air inlet thread	1/4"								



1 ANEST IWATA W-400

2

3

4 CUP 600 ml

Alle Artikel und Ersatzteile lieferbar.
Rabatt auf Anfrage
All products and spare parts available.
Conditions on request.
www.gemini-airless.de/anestiwata

ANEST IWATA

Pos.	Art.-Nr. Part-No.	Artikelbeschreibung Description	Listenpreis List price	Netto-Stückpreis bei Net unit price for
------	-------------------	---------------------------------	------------------------	---

W-400				
1	1324140xx	Luftpistole mit Düse / Air gun with tip 0.8/1.0/1.2/1.3/1.4/1.6/1.8/2.0/2.5 mm	395,-	
2	938xx	Düse & Nadel / Nozzle & needle 0.8/1.0/1.2/1.3/1.4/1.6/1.8/2.0/2.5 mm	106,-	
3	93830610B	Luftkappe / AirCap - LV2 - 0.8/1.0/1.2/1.3/1.4/1.6 mm	103,-	
	93859611	Luftkappe / AirCap - LV1 - 1.8 mm		
	93814610B	Luftkappe / AirCap - R2 - 2.0 mm		
	93813610B	Luftkappe / AirCap - W1 - 2.5 mm		
4	14011001	Fließbecher / Gravity cup - PCG-6PE M16x1.5 (F) - 600 ml	56,50	

Model	Ø 0.8	Ø 1.0	Ø 1.2	Ø 1.3	Ø 1.4	Ø 1.6	Ø 1.8	Ø 2.0	Ø 2.5
Luftbedarf Air consumption	280 l/min						290 l/min	360 l/min	
Material Durchfluss Fluid output	60 ml/min	95 ml/min	100 ml/min	160 ml/min	210 ml/min	240 ml/min	320 ml/min	460 ml/min	360 ml/min
Gewicht Weight	380 g								
Anschlussgewinde Fluid inlet thread	M16x1.5								
Luftanschluss Air inlet thread	1/4"								



Pos.	Art.-Nr. Part-No.	Artikelbeschreibung Description	Listenpreis List price	Netto-Stückpreis bei Net unit price for
			€/Stück €/piece	
Niederdruck-Tandemschlauch / Low pressure twin hose				
1	ND-DS-2.5	6x8 mm - 2.5 m - 1/4" BSP - 15 bar Arbeitsdruck / working pressure	26,-	
	ND-DS-7.5	6x8 mm - 7.5 m - 1/4" BSP - 15 bar Arbeitsdruck / working pressure	52,-	
	ND-DS-10	6x8 mm - 10 m - 1/4" BSP - 15 bar Arbeitsdruck / working pressure	64,-	
	ND-DS-15	6x8 mm - 15 m - 1/4" BSP - 15 bar Arbeitsdruck / working pressure	98,-	

Niederdruckschlauch - elektrisch leitfähig - lösemittelbeständig Low pressure hose - electroconductive - solvent resistant			€/Stück €/piece	
2	TPU20-6	6x10 mm - 20 bar Arbeitsdruck / working pressure (Rolle / Reel = 50 m)	7,40	

Luftschlauch / Air hose			€/Stück €/piece	
3	TPU20-6-AIR	6x10 mm - 20 bar Arbeitsdruck / working pressure (Rolle / Reel = 200 m)	5,80	



Pos.	Art.-Nr. Part-No.	Artikelbeschreibung Description	Listenpreis List price	Netto-Stückpreis bei Net unit price for
			€/Stück €/piece	
Luft / Air				
1	JF-1/4	Luftregelventil / Air flow control valve - 1/4"	12,-	
2	LM-50	Luftregelventil mit Manometer - 1/4" - LowBudget Air flow control valve with gauge - 1/4" - LowBudget	32,-	
3	LT-331	Schnellkupplung / Quick coupling - 360° - 1/4" (F)	16,-	

Fließbecher / Gravity cups - 600 ml			€/Stück €/piece	
4	CUP-M16-F	M16x1.5 (F)	18,-	
	CUP-M16-QUICK	M16x1.5 (M) - Schnellkupplung / Quick coupling		
	CUP-3/8-F	3/8" (F)		

Filter			€/Stück €/piece	
5	35155-60-NY-LB	60 Maschen - Nylon / 60 mesh - Nylon	1,20	
	35155-60-SS-LB	60 Maschen - Edelstahl / 60 mesh - Stainless steel		
	35155-100-NY-LB	100 Maschen - Nylon / 100 mesh - Nylon		
	35155-100-SS-LB	100 Maschen - Edelstahl / 100 mesh - Stainless steel		

Art.-Nr. / Part-No.
EP2150-SET

**ASM EP2150
SprayPack "Airless"**

- Ansaugsystem mit Filter
- Schlauch: 1/4" - 15 m
- Pistole: ASM 500
- Halter & Düse: UniTip 515
- Suction system with filter
- Hose: 1/4" - 15 m
- Gun: ASM 500
- Base & tip: UniTip 515

2.600,- € Listenpreis
List price



1.8 Ltr./min.

0.021"

230 bar

Art.-Nr. / Part-No.
EP3150-SET

**ASM EP3150
SprayPack "Airless"**

- Ansaugsystem mit Filter
- Schlauch: 1/4" - 15 m
- Pistole: ASM 500
- Halter & Düse: UniTip 517
- Suction system with filter
- Hose: 1/4" - 15 m
- Gun: ASM 500
- Base & tip: UniTip 517v

5.800,- € Listenpreis
List price



3.6 Ltr./min.

0.031"

230 bar

Art.-Nr. / Part-No.
EP2550-SET

**ASM EP2550
SprayPack "Airless"**

- Ansaugsystem mit Filter
- Schlauch: 1/4" - 15 m
- Pistole: ASM 500
- Halter & Düse: UniTip 517
- Suction system with filter
- Hose: 1/4" - 15 m
- Gun: ASM 500
- Base & tip: UniTip 517

3.400,- € Listenpreis
List price



2.5 Ltr./min.

0.025"

230 bar

Art.-Nr. / Part-No.
EP3750-SET

**ASM EP3750
SprayPack "Airless"**

- Ansaugsystem mit Filter
- Schlauch: 3/8" - 15 m
- Schlauchpeitsche: 1/4" - 1.5 m
- Pistole: ASM 500
- Halter & Düsen: UniTip 517/535
- Suction system with filter
- Hose: 3/8" - 15 m
- Hose whip: 1/4" - 1.5 m
- Gun: ASM 500
- Base & tips: UniTip 517/535

8.200,- € Listenpreis
List price



4.5 Ltr./min.

0.037"

230 bar



Pos.	Art.-Nr. Part-No.	Artikelbeschreibung Description	Listenpreis List price	Netto-Stückpreis bei Net unit price for
			€/Stück €/piece	
1	500-G-UT	ASM 500 - 250 bar - 7/8" - 1/4" NPS - 2/4 Finger Inkl. Düsenhalter UniTip und Düse 517 / With base Uni Tip and tip 517	290,-	
2	670-G	ASM6700 Combo-Gun - 1/4" - 7/8"	290,-	
	670-F	ASM6700 Combo-Gun - 1/4" - 11/16"		
			€/Stück €/piece	
3	59-xxx	SUPER ZIP - Wendedüse / Reversible tip - 350 bar	46,-	
4	5901-F	SUPER ZIP - Düsenhalter / Tip base - 11/16"	42,-	
	5901-G	SUPER ZIP - Düsenhalter / Tip base - 7/8"		
	5907	SUPER ZIP - Dichtungssatz / Seal kit		
5	69-xxx	UniTip - Wendedüse / Reversible tip - 350 bar	46,-	
	69FF-xxx	UniTip - Wendedüse mit Vorzerstäuber / Reversible tip with preorifice - 350 bar	50,-	
6	6901-F	UniTip - Düsenhalter / Tip base - 11/16"	42,-	
	6901-G	UniTip - Düsenhalter / Tip base - 7/8"	42,-	
	6901-M1.0	UniTip - Düsenhalter / Tip base - M18x1.0	46,-	
	6901-M1.5	UniTip - Düsenhalter / Tip base - M18x1.5	46,-	
	6907	Dichtungssatz (5x) / Seal kit (5x)	32,-	



Düsenverlängerungen / Pole-extensions

Pos.	Art.-Nr. Part-No.	Artikelbeschreibung Description	Listenpreis List price	Netto-Stückpreis bei Net unit price for
			€/Stück €/piece	
1	32-150-F	15 cm - 11/16" - incl. Adapter	68,-	
	32-150-G	15 cm - 7/8" - incl. Adapter		
	32-300-F	30 cm - 11/16" - incl. Adapter	70,-	
	32-300-G	30 cm - 7/8" - incl. Adapter		
	32-450-F	45 cm - 11/16" - incl. Adapter	76,-	
	32-450-G	45 cm - 7/8" - incl. Adapter		
	32-600-F	60 cm - 11/16" - incl. Adapter		
	32-600-G	60 cm - 7/8" - incl. Adapter	80,-	
2	32-1000	Verlängerung / Maxi Pole only - 1 m	120,-	
	32-1000-F	Mit Kniegelenk / With anglehead - 1 m - 11/16"	198,-	
	32-1000-G	Mit Kniegelenk / With anglehead - 1 m - 7/8"		
3	32-7506-F	Kniegelenk / Anglehead - 11/16"	56,-	
	32-7506-G	Kniegelenk / Anglehead - 7/8"		
4	32-7551-F	Adapter für Pistole / Adapter for gun - 11/16"	38,-	
	32-7551-G	Adapter für Pistole / Adapter for gun - 7/8"		
5	32-3430-F	Adapter für Düsenhalter / Adapter for tip base - 11/16"	28,-	
	32-3430-G	Adapter für Düsenhalter / Adapter for tip base - 7/8"		

ASM Roller

6	770900F-M	Rollervorsatz kpl. / Roller unit cpl. - 9" (GR244271)	160,-	
7	7722	Walze fein / Cover smooth - 13 mm (GR186944)	30,-	
	7723	Walze mittel / Cover medium - 19 mm (GR186945)		

Art.-Nr. / Part-No.
GR17E667

**GRACO MARK VII ProContractor
SprayPack**

- Ansaugsystem mit Filter
- Schlauch: 1/2" - 15 m
- Schlauchpeitsche: 3/8" - 3.5 m
- Pistole: HD Blue Texture
- Halter & Düsen: HDA 531/541

- Suction system with filter
- Hose: 1/2" - 15 m
- Hose whip: 3/8" - 3.5 m
- Gun: HD Blue Texture
- Base & tips: HDA 531/541

12.400,- € Listenpreis
List price



**SOLANGE DER VORRAT REICHT
WHILE STOCKS LAST**

Art.-Nr. / Part-No.
GR17E671

**GRACO MARK X ProContractor
SprayPack**

- Ansaugsystem mit Filter
- Schlauch: 1/2" - 15 m
- Schlauchpeitsche: 3/8" - 3.5 m
- Pistole: HD Inline Texture
- Halter & Düsen: HDA 531/541

- Suction system with filter
- Hose: 1/2" - 15 m
- Hose whip: 3/8" - 3.5 m
- Gun: HD Inline Texture
- Base & tips: HDA 531/541

13.910,- € Listenpreis
List price



**SOLANGE DER VORRAT REICHT
WHILE STOCKS LAST**



**SOLANGE DER VORRAT REICHT
WHILE STOCKS LAST**

Art.-Nr. / Part-No.
GR289587

GRACO

Sackpresse für Materialbehälter
Bag press for material hopper

873,- € Listenpreis
List price



**SOLANGE DER VORRAT REICHT
WHILE STOCKS LAST**

Art.-Nr. / Part-No.
GR287987

GRACO

Materialbehälter 90 Ltr.
Material hopper 90 ltr.

1.007,- € Listenpreis
List price

Art.-Nr. / Part-No.
GR17N226-1

GRACO FTXpress

- 250 bar
- 7/8"
- 1/4" NPS
- 2/4 Finger

240,- € Listenpreis
List price



Inklusive
2-Finger-Abzug
Including
2-finger-trigger

Art.-Nr. / Part-No.
GR17N226

Großverpackung 10 Stück
10 pieces **bulk packed**

1.940,- € Listenpreis
List price

Art.-Nr. / Part-No.
GR17P258

**GRACO UltraMax
Cordless**

990,- € Listenpreis
List price



Art.-Nr. / Part-No.
GR20B476

**GRACO Ultra QuickShot
Cordless**

1.445,- € Listenpreis
List price



GRACO

Pos.	Art.-Nr. Part-No.	Artikelbeschreibung Description	Listenpreis List price	Netto-Stückpreis bei Net unit price for
			€/Stück €/piece	

RAC V

1	GR262-xxx	Wendedüse / Reversible tip - 350 bar	117,-	
2	GR243161	Düsenhalter / Tip base - 7/8"	80,-	
	GR243263	Düsenhalter / Tip base - 11/16"		

RAC X

3	LTX-xxx	Wendedüse blau - 350 bar - Größe .007-.013 Reversible tip blue - 350 bar - Size .007-.013	82,-	
	PAA-xxx	Wendedüse blau - 350 bar - Größe .015-.025 Reversible tip blue - 350 bar - Size .015-.025		
	HDA-xxx	Wendedüse braun - 350 bar - Größe .027-.071 Reversible tip brown - 350 bar - Size .027-.071		
	FFLP-xxx	Wendedüse grün mit Vorzerstäuber - 350 bar Reversible tip green with preorifice - 350 bar	93,-	
	LP-xxx	Wendedüse grün - Niederdruck Reversible tip green - low pressure		
4	GR246215	Düsenhalter / Tip base - 7/8"	58,-	
	GR246437	Düsenhalter / Tip base - 11/16"		



GRACO

Pos.	Art.-Nr. Part-No.	Artikelbeschreibung Description	Listenpreis List price	Netto-Stückpreis bei Net unit price for
			€/Stück €/piece	

Flachstrahl / Flat jet

1	GR269-xxx	Airless Contractor Düse bis Größe .035" Airless contractor tip up to size .035"	44,-	
2	GR163-xxx	Airless Standarddüse bis Größe .081" Airless standard tip up to size .081"	76,-	
3	GR163-xxx	Airless Feinspritzdüse mit Vorzerstäuber bis Größe .032" Airless fine finish tip with preorifice up to size .032"	111,-	

GRACO JET-ROLLER

			€/Stück €/piece	
4	24V490	18 cm + CleanShot + RAC-X 515 (Pistole + Verlängerung + CleanShot + Düse) 18 cm + CleanShot + RAC-X 515 (gun + extension + CleanShot + tip)	806,-	
	24V491	25 cm + CleanShot + RAC-X 721 (Pistole + Verlängerung + CleanShot + Düse) 25 cm + CleanShot + RAC-X 721 (gun + extension + CleanShot + tip)		
5	287030	CleanShot - 7/8"	268,-	

Alle Artikel und Ersatzteile lieferbar.
 Rabatt auf Anfrage
All products and spare parts available.
 Conditions on request.
www.gemini-airless.de/graco

Art.-Nr. / Part-No.
GRK60FH1

**GRACO KING 60:1
SprayPack**

- Ansaugsystem mit Filter
- Schlauch: 3/8" - 15 m
- Schlauchpeitsche: 1/4" - 1.8 m
- Pistole: XTR
- Halter & Düse: XHD 519

- Suction system with filter
- Hose: 3/8" - 15 m
- Hose whip: 1/4" - 1.8 m
- Gun: XTR
- Base & tip: XHD 519

8.035,- € Listenpreis
List price

Art.-Nr. / Part-No.
GRK70FH1

**GRACO KING 70:1
SprayPack**

- Ansaugsystem mit Filter
- Schlauch: 3/8" - 15 m
- Schlauchpeitsche: 1/4" - 1.8 m
- Pistole: XTR
- Halter & Düse: XHD 519

- Suction system with filter
- Hose: 3/8" - 15 m
- Hose whip: 1/4" - 1.8 m
- Gun: XTR
- Base & tip: XHD 519

8.035,- € Listenpreis
List price



1 XTR520
345 bar

2 XTR720
500 bar



3 GRACO
XHD
500 bar

4 GRACO
7/8"
11/16"

GRACO

Pos.	Art.-Nr. Part-No.	Artikelbeschreibung Description	Listenpreis	Netto-Stückpreis bei
			List price	Net unit price for
			€/Stück	
			€/piece	

XTR 520 & 720

1	XTR520	345 bar - 4 Finger - ohne Düse / without tip	499,-	
2	XTR720	500 bar - 4 Finger - ohne Düse / without tip	551,-	

XHD

3	XHD-xxx	Wendedüse / Reversible tip - 500 bar	99,-	
4	XHD001	Düsenhalter / Tip base - 7/8"	53,-	
	XHD005	Düsenhalter / Tip base - 11/16"		



Alle Artikel und Ersatzteile lieferbar.
Rabatt auf Anfrage
All products and spare parts available.
Conditions on request.
www.gemini-airless.de/graco





Art.-Nr. / Part-No.
GR233500

GRACO TRITON 1:1 - 150
• 3/8"
• 32 Ltr. / min.
• Aluminium

1.387,- € Listenpreis
List price

Art.-Nr. / Part-No.
GR233501

• Edelstahl Variante
• *Stainless steel version*

2.323,- € Listenpreis
List price

Art.-Nr. / Part-No.
GR234915

GRACO TRITON 1:1 - 308
3/8" - 7.6 Ltr./min. - Aluminium

SprayPack auf Fahrwagen

- AC-Regler
- Ansaugsystem mit Filter
- Tandemschlauch 7.5 m
- AirPro Pistole 1.4 mm

SprayPack on trolley

- AC-regulator
- Suction system with filter
- Twin-hose 7.5 m
- AirPro gun 1.4 mm

2.726,- € Listenpreis
List price



Art.-Nr. / Part-No.
GRG15C09

GRACO MERKUR AIRCOMBI
15:1 - 25 cm³ - 1.5 Ltr./min.

SprayPack auf Fahrwagen

- AC-Regler
- Ansaugsystem mit HD-Filter
- Tandemschlauch 7.5 m
- PerformAA 15 Pistole & Düse

SprayPack on trolley

- AC-regulator
- Suction system with HP-filter
- Twin-hose 7.5 m
- PerformAA 15 gun & tip

4.936,- € Listenpreis
List price

Art.-Nr. / Part-No.
GRG30C25

GRACO MERKUR AIRCOMBI
30:1 - 25 cm³ - 1.5 Ltr./min.

SprayPack auf Fahrwagen

- AC-Regler
- Ansaugsystem mit HD-Filter
- Tandemschlauch 7.5 m
- PerformAA 50 Pistole & Düse

SprayPack on trolley

- AC-regulator
- Suction system with HP-filter
- Twin-hose 7.5 m
- PerformAA 50 gun & tip

5.128,- € Listenpreis
List price



Art.-Nr. / Part-No.
GRG30C67

GRACO MERKUR AIRCOMBI
30:1 - 75 cm³ - 4.5 Ltr./min.

SprayPack auf Fahrwagen

- AC-Regler
- Ansaugsystem mit HD-Filter
- Tandemschlauch 7.5 m
- PerformAA 50 Pistole & Düse

SprayPack on trolley

- AC-regulator
- Suction system with HP-filter
- Twin-hose 7.5 m
- PerformAA 50 gun & tip

6.088,- € Listenpreis
List price

Art.-Nr. / Part-No.
GRG36C09

GRACO MERKUR AIRCOMBI
36:1 - 100 cm³ - 6.0 Ltr./min.

SprayPack auf Fahrwagen

- AC-Regler
- Ansaugsystem mit HD-Filter
- Tandemschlauch 7.5 m
- PerformAA 50 Pistole & Düse

SprayPack on trolley

- AC-regulator
- Suction system with HP-filter
- Twin-hose 7.5 m
- PerformAA 50 gun & tip

6.858,- € Listenpreis
List price



Alle Artikel und Ersatzteile lieferbar.
Rabatt auf Anfrage
All products and spare parts available.
Conditions on request.
www.gemini-airless.de/graco



Art.-Nr. / Part-No.
GR26B512

GRACO PerformAA 50

- Pistole mit Drehgelenk
- Luftkappe (WL)
- Düse AXM 413
- Gun with swivel
- AirCap (WL)
- Tip AXM 413

1.161,- € Listenpreis
List price



Art.-Nr. / Part-No.
GR26B518

GRACO PerformAA 50

- Pistole mit Drehgelenk
- Wendedüsensystem LTX413
- Gun with swivel
- Reversible tip system LTX413

1.161,- € Listenpreis
List price



Art.-Nr. / Part-No.
GR-AAM-xxx
Standard

GRACO AAM
AirCombi Düse / Tip

146,- € Listenpreis
List price



Art.-Nr. / Part-No.
GR-AAF-xxx
Fine Finish

GRACO AAF
Mit Vorzerstäuber
With preorifice

148,- € Listenpreis
List price

GR-AXM-xxx
Standard

GRACO AXM
AirCombi Düse / Tip

110,- € Listenpreis
List price



Art.-Nr. / Part-No.
GR-AXF-xxx
Fine Finish

GRACO AXF
Mit Vorzerstäuber
With preorifice

131,- € Listenpreis
List price

Art.-Nr. / Part-No.
GR-AEM-xxx
Standard

GRACO AEM
E-Static

154,- € Listenpreis
List price



Art.-Nr. / Part-No.
GR-GG3-xxx
Standard

GRACO GG3
E-Static

156,- € Listenpreis
List price



Alle Artikel und Ersatzteile lieferbar.
 Rabatt auf Anfrage
All products and spare parts available.
 Conditions on request.
www.gemini-airless.de/graco



Art.-Nr. / Part-No.
W394155

WAGNER GM4600
Ohne Luftkappe und Düse
Without AirCap and tip

594,56 € Listenpreis
List price



Art.-Nr. / Part-No.
W2313585

WAGNER GM4700
Ohne Luftkappe und Düse
Without AirCap and tip

685,- € Listenpreis
List price

Art.-Nr. / Part-No.
W231358x

WAGNER GM4700
Mit Luftkappe ohne Düse
With AirCap without tip

Red..... W2313586
Blue W2313587

855,- € Listenpreis
List price



Art.-Nr. / Part-No.
W231349x

WAGNER Luftkappe / AirCap
Red.....W2313494
BlueW2313497

174,90 € Listenpreis
List price



Art.-Nr. / Part-No.
W231572x

WAGNER Cage filter (10x)
Weiß / White - 50 M.....W2315726
Gelb / Yellow - 100 M.....W2315725
Blau / Blue - 150 M.....W2315724
Rot / Red - 200 M.....W2315723

25,50 € Listenpreis
List price



Art.-Nr. / Part-No.
W379-xxx

WAGNER ACF3000
250 bar

125,90 € Listenpreis
List price



Art.-Nr. / Part-No.
W321-xxx

WAGNER ACF3000 plus
250 bar - mit Vorzerstäuber
250 bar - with preorifice

141,90 € Listenpreis
List price



Art.-Nr. / Part-No.
W395-xxx

WAGNER ACF5000
250 bar - E-Static

128,90 € Listenpreis
List price



Art.-Nr. / Part-No.
W132-7xx

WAGNER
250 bar - Rundstrahldüse
250 bar - Round jet tip

164,90 € Listenpreis
List price



Art.-Nr. / Part-No.
W1088-xxx

WAGNER TIP
530 bar

111,90 € Listenpreis
List price



Art.-Nr. / Part-No.
W1088001

WAGNER
Düsenhalter - 11/16"
Tip base - 11/16"

86,50 € Listenpreis
List price

Alle Artikel und Ersatzteile lieferbar.
 Rabatt auf Anfrage.
All products and spare parts available.
 Conditions on request.
www.gemini-airless.de/wagner



Art.-Nr. / Part-No.
WIWA0015016

WIWA 500 HD
• 500 bar
• 11/16"
• 1/4" NPS

483,- € Listenpreis
List price



Art.-Nr. / Part-No.
WIWA0012092

WIWA 500 HD Front
• 500 bar
• 11/16"
• 1/4" NPS

477,- € Listenpreis
List price

 **Alle Artikel und Ersatzteile lieferbar.**
Rabatt auf Anfrage
All products and spare parts available.
Conditions on request.
www.gemini-airless.de/wiwa



Art.-Nr. / Part-No.
KR135732200

KREMLIN Xcite +
• 200 bar
• Luftkappe / AirCap VX24

1.162,38 € Listenpreis
List price

Art.-Nr. / Part-No.
KR134xxxx4

KREMLIN
AirCombi Düse
AirCombi Tip

131,89 € Listenpreis
List price

Art.-Nr. / Part-No.
KR134xxxx2

KREMLIN
AirCombi Düse
mit Vorzerstäuber
AirCombi Tip
with preorifice

139,77 € Listenpreis
List price



 **Alle Artikel und Ersatzteile lieferbar.**
Rabatt auf Anfrage
All products and spare parts available.
Conditions on request.
www.gemini-airless.de/kremlin





Preis auf Anfrage
Price on request

Preis auf Anfrage
Price on request



Art.-Nr. / Part-No.
G-DI-15AX-LCD
15 Liter
G-DI-30AX-LCD
30 Liter
G-DI-30AX-LCD
60 Liter

Geld sparen durch Lösemittel-Recycling!

- Explosionsgeschützt / ATEX geprüft
- Zum Recyclen von entflammaren und nicht entflammaren Lösemitteln
- Ladekapazität: 15 / 30 / 60 Liter
- Stromspannung: 230 V - 50 Hz
- Elektrischer Anschluss: Einphasig & Erdung
- Elektrische Sicherung: II2G IIA T3 bis T2
- Dampfkondensator: Edelstahl – Luftgekühlt
- Kein Verkauf innerhalb Deutschlands

Recover Solvent - Safe Money!

- Explosion proof version / ATEX approved
- For recycling of flammable and not flammable solvents
- Loading capacity: 15 / 30 / 60 litres
- Voltage: 230 V - 50 Hz
- Electrical supply: single phase & earth
- Electrical protection: II2G IIA T3 to T2
- Vapour condenser: stainless steel – cooled by air
- No sales to Germany

Dichtung / Gasket

- 15 Liter**
StandardG-F359001
AcetoneG-F359002
UniversalG-F239004
- 30 Liter**
StandardG-F359006
AcetoneG-F359007
UniversalG-F239010
- 60 Liter**
StandardG-Fxxxxxxx
AcetoneG-Fxxxxxxx
UniversalG-Fxxxxxxx

Preis auf Anfrage
Price on request

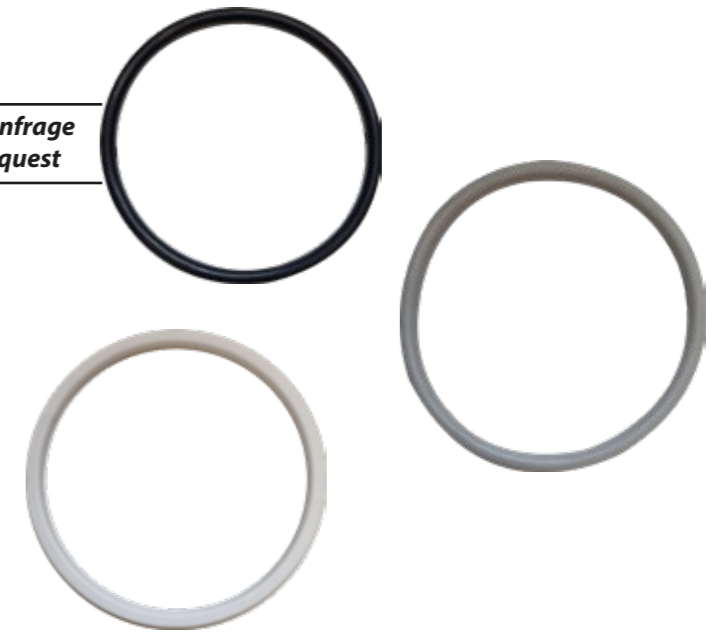

Art.-Nr. / Part-No.
G-F38430x

Distiller bags
50 Stück / 50 pieces

- 15 Ltr.....G-F384306
30 Ltr.....G-F384307
60 Ltr.....G-F384308

Preis auf Anfrage
Price on request

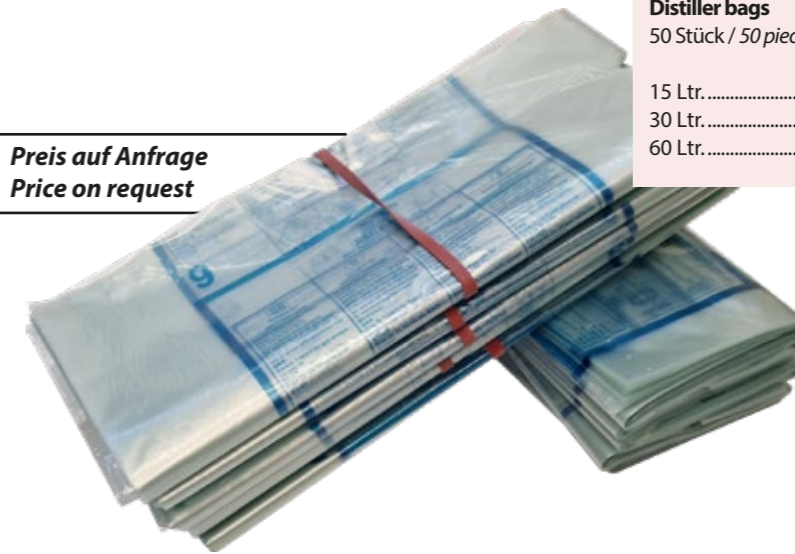

Alle Artikel und Ersatzteile lieferbar.
Rabatt auf Anfrage.
All products and spare parts available.
Conditions on request.



Liefer- und Zahlungsbedingungen

- Preise: Gültig ab 01.02.2024 zuzüglich ges. MwSt.
- Lieferung: Ab Werk zuzüglich Versandkosten
- Lieferservice: Auf Wunsch versenden wir Ihre Bestellungen neutral oder mit Ihren Versandunterlagen direkt an Ihren Kunden.
- Mindestbestellwert: Unter 50,00 € - Zuschlag 10,00 € netto
- Zahlung: Nach Vereinbarung
- Rücksendung: Für Rücksendungen die ohne unser Verschulden erfolgen, stellen wir 20% des Warenwertes für Abwicklung, Wiedereinlagerung in Rechnung.

Wir liefern Zubehör- und Ersatzteile für alle gängigen Marken. Gerne unterbreiten wir Ihnen auf Anfrage unsere Angebote.

Kein Vertrieb der Handelsmarke Airless nach Frankreich. Es gelten unsere allgemeinen Verkaufs- und Lieferbedingungen.

Technische Änderungen bleiben uns vorbehalten.

Terms and Conditions of Delivery and Payment

- Prices: Valid from 01.02.2024 additionally VAT
- Delivery: Ex works plus forwarding charges
- Delivery-Service: We deliver your order neutral or with your shipping documents directly to your customer on request.
- Minimum order value: Below 50,00 € - Surcharge 10,00 € net
- Payment: By agreement
- Returns: Returns which are independent of our negligence, we charge 20% of the merchandise value for transaction and backshipping.

We deliver accessories and spare-parts for all established brands. We have much pleasure to submit you our quotation.

No sales of the trademark Airless to France. Our general sales terms and delivery conditions apply.

Subject to change of technical data and information without notice.





Gemini GmbH
Rheinstraße 7
88046 Friedrichshafen
Germany

Tel.: +49 7541 98156-15
Fax: +49 7541 98156-25
E-Mail: info@gemini-airless.de
Web: www.gemini-airless.de